

Feb.
1938

25c
Per Copy

RADIO WORLD

REG. U.S. PAT. OFF.

**360-DEGREE ANGLE
FOR RAY-INDICATING
TUBE**

**LEAKAGE REDUCTION
IN SIGNAL
GENERATORS**

**TRANSMISSION
LINES FOR HIGH
FREQUENCIES**

**HIGH FIDELITY
DETECTOR WITH
PUSH-PULL A. F.**

**PRESIDENT OF U. S.
BLASPHEMED IN
HOAX "AD"**

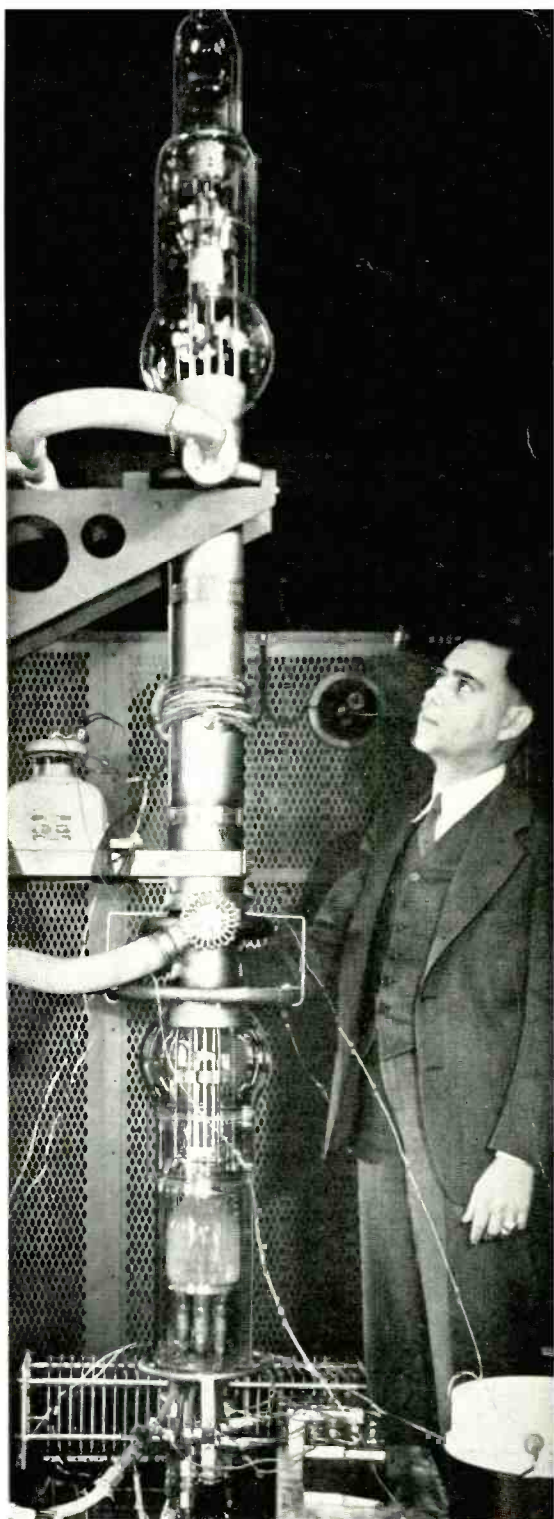

An experimental model 250 kw transmitting tube is being tested at Whippany Field Laboratory of Bell Telephone Laboratories.

Ready now
**for tomorrow's
radio needs...**

CORNELL - DUBILIER CAPACITORS

For Radio Receiving . . . Transmitting . . . Television . . . Power Amplification . . . Signal Systems . . . Power-Factor Correction . . . Telephony . . . Aircraft Instruments and all Industrial Purposes.

Designed with vision, laboratory proven, built to endure, Cornell-Dubilier, the World's Most Complete line of Condensers—engineered to meet Tomorrow's radio needs today.

Step out ahead with C-D, for twenty-eight years the international symbol of dependability in capacitors.

For complete information and technical data write to

1024 Hamilton Boulevard, South Plainfield, N. J.
World's Largest and Oldest Exclusive Manufacturer of Capacitors

**MICA -- PAPER -- DYKANOL
WET & DRY ELECTROLYTICS**



CORNELL-DUBILIER
ELECTRIC CORPORATION
South Plainfield, New Jersey



I jumped from \$18 a week to \$50
 -- a Free Book started me toward this
GOOD PAY IN RADIO

HERE'S
How it Happened
 by S. J. E.
 (NAME AND ADDRESS SENT UPON REQUEST)



"\$18 a week job in shoe factory. Probably be at it today if hadn't read about radio opportunities and started home training."

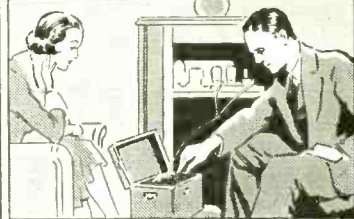

"National Radio Institute training so practical was soon ready to make \$5 to \$15 a week, spare time servicing radio sets."

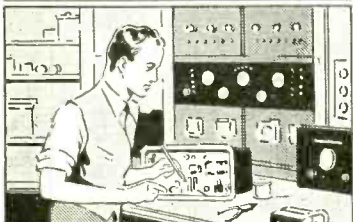

"Training course finished, accepted job as serviceman with radio store. 3 weeks later, made service manager at more than twice previous shoe factory earnings."

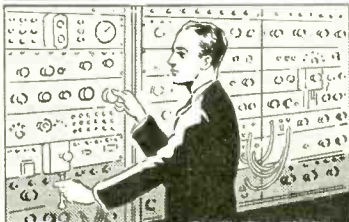

"Eight months later N. R. I. employment dept. sent me to KWCR as radio operator. Am now radio engineer at WSUI, and also connected with television station W9XK."



"N. R. I. training took me out of low pay shoe factory job and into Radio at good pay. Fast growing radio field is wide open to properly trained men."



Find out today how I Train You at Home
to BE A RADIO EXPERT

Many Make \$30, \$50, \$75 a Week

J. E. Smith, President National Radio Institute Established 1914

Do you too want a better job? Do you too want to make more money? Radio offers many spare time and full time opportunities for good pay.

to do Radio repair jobs. Throughout your training I send plans and ideas that made good spare time money for hundreds. I send Special Equipment to conduct experiments, build circuits, get practical experience. I GIVE YOU A COMPLETE, MODERN, PROFESSIONAL ALL WAVE, ALL PURPOSE RADIO SET SERVICING INSTRUMENT TO HELP SERVICE SETS QUICKER—SAVE TIME, MAKE MORE MONEY.

and full time opportunities, also those coming in Television; tells about my Training in Radio and Television; shows you 131 letters from men I trained, shows what they are doing, earning; shows my Money Back Agreement. MAIL COUPON in an envelope, or paste on penny post card—NOW!

Get Ready Now for Jobs Like These
 Broad-casting stations employ engineers, operators, station managers and pay up to \$5,000 a year. Spare time Radio set servicing pays many \$200 to \$500 a year—full time servicing jobs pay many \$30, \$50, \$75 a week. Many Radio Experts are operating full or part time Radio businesses. Radio manufacturers and jobbers employ testers, inspectors, foremen, engineers, servicemen, paying up to \$6,000 a year. Radio operators on ships get good pay, see the world. Automobile, police, aviation, commercial Radio, loud speaker systems, offer good opportunities now and for the future. Television promises good jobs soon. Men I trained have good jobs in these branches of Radio.

Many Make \$5, \$10, \$15 a Week Extra in Spare Time While Learning

Almost every neighborhood needs a good spare time serviceman. The day you enroll I start sending Extra Money Job Sheets showing how

Find Out What Radio Offers You
 Mail the coupon now for "Rich Rewards in Radio." It's free to any fellow over 16 years old. It points out Radio's spare time

J. E. SMITH, President, Dept. 8B M 4 National Radio Institute Washington, D. C.



J. E. Smith, President, Dept. 8B M 4 National Radio Institute, Washington, D. C.
 Dear Mr. Smith: Without obligating me, send "Rich Rewards in Radio," which points out spare time and full time opportunities in Radio, and explains your practical method of training at home in spare time to become a Radio Expert. (Please write plainly.)

Name..... Age.....
 Address.....
 City..... State.....

A NEW INSTRUMENT

BY

SUPERIOR

Combination All-Wave
Signal Generator

Plus

A Complete Tube Tester

Only \$19.90

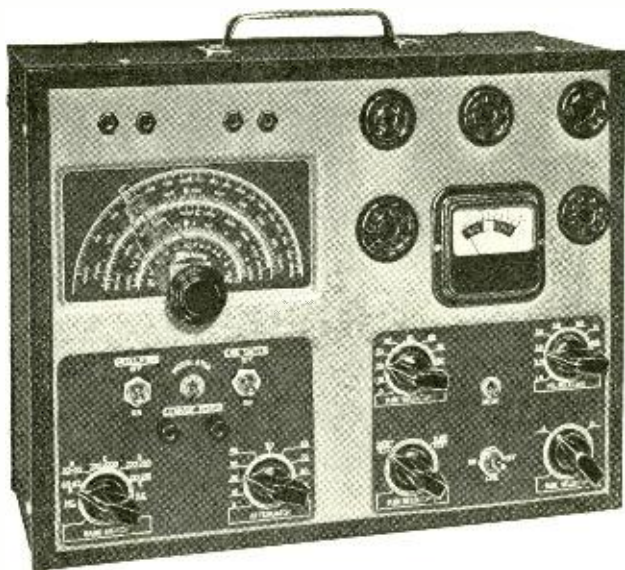

- Truly the greatest value ever offered by any instrument manufacturer! There is no comparison to this COMBINATION INSTRUMENT, made by Superior, at the price of \$19.90. Consists of two fully complete units housed in a single metal cabinet of attractive design: (1) an ALL-WAVE SIGNAL GENERATOR and (2) COMPLETE TUBE TESTER.
- The Signal Generator has a range of from 110 kc. to 22 mc., all fundamental frequencies, in five bands—with front panel band-switching control.
- All frequencies are directly calibrated on the dial, and a 4 to 1 planetary drive is incorporated to allow for slow precise tuning adjustment.
- R.F. signal with or without audio modulation, at the control of the operator.
- Separate R.F. and A.F. outputs, with two A.F. amplitude levels.
- Accuracy 1 per cent on I.F. bands, 2 per cent on short-waves.
- Separate Neon leakage test circuit, for testing condensers, etc.
- Employs two tubes; 2—6A7's and one special neon modulator tube. The TUBE TESTER tests all 4, 5, 6, 7 and octal base tubes, including diode tubes.
- Incorporates separate neon short or leakage test, to determine whether tubes are bad, noisy or leaky.
- English reading meter, with "BAD—?—GOOD" scale.
- Uses minimum number of operating controls, allowing tube tests to be made quickly and accurately.
- Sturdy, reliable and foolproof emission type circuit.

Works on 90-120 Volts, 60 Cycle A.C.

Shipping weight 19 lbs.

SUPERIOR INSTRUMENTS

DeLuxe Superior GENEMETER

100 Kc to 100 Mc With Variable Audio

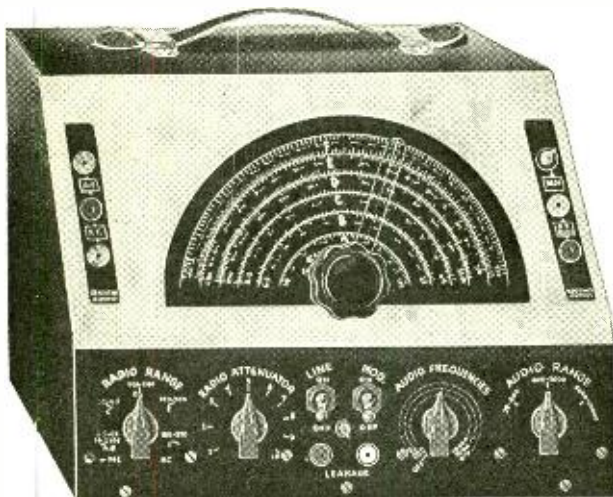

FEATURES:

1. Direct reading in frequencies, 100 kc —22 mc, in five bands, all fundamentals, by front-panel switching. Ultra band by harmonics to 105 mc, also direct-reading.
2. Direct reading in frequencies, 25—10,000 cycles, in three bands, all fundamentals, by front-panel switching.
3. R.F. and A.F. outputs independently obtainable alone, or with A.F. (any frequency) modulating R.F.
4. Output meter for connection across primary of receivers' output transformer for peaking with modulation "on."
5. R.F. is subject to attenuation, and oscillation leakage is minimum.
6. Condenser and other leakages, tested, to 100 megohms.
7. Main dial protracted on 7½ in. diameter, used full size, with precision pointer (no parallax), and 4-to-1 vernier planetary drive.
8. All services on 90-130 volts a.c. or d.c.

Shipping weight, 10 lbs.

\$14.40

Complete with Four Tubes

ALL the refinements that you would demand of a costly Signal Generator are embodied in our new GENEMETER. First in importance is accuracy. The GENEMETER has it—½% on intermediate and broadcast bands, 2% on short waves. Modulation must be present or absent by switching. It is. And, besides, the audio is variable. Direct reading in frequencies, it permits response measurements of amplifiers.

Beauty? The picture tells the story. Output meter? That is included, too. Even condenser and other leakage may be tested. All frequencies, radio and audio, are direct-reading. The large dial is 4-to-1 vernier, with costly planetary drive.

The Year's Sensation

The 27

SPLENDID PURPOSES

The ALLMETER PERFORMS

1,000 ohms per volt, d'Arsonval movement, direct reading



- 0-15 Volts A.C.
- 0-150 Volts A.C.
- 0-750 Volts A.C.
- 0-15 Volts D.C.
- 0-150 Volts D.C.
- 0-750 Volts D.C.
- 0-15 Milliamperes A.C.
- 0-150 Milliamperes A.C.

- 0-750 Milliamperes A.C.
- 0-1 Milliampere D.C.
- 0-15 Milliamperes D.C.
- 0-150 Milliamperes D.C.
- 0-750 Milliamperes D.C.
- Continuity Tester
- .01-50 Mfd.
- .03-500 Ohms

- 500-500,000 Ohms
- 12 to +10 Decibels
- +8 to +30 Decibels
- By Interpolation
- +28 to +50 Decibels
- By Interpolation

- Inductance,
- 5-1,000 Henries
- V.T.V.M., 0-150 Volts A.C.

- V.T.V.M., 0-150 Volts A.C.
- V.T.V.M., 0-750 Volts A.C.
- V.T.V.M., 0-15 Volts D.C.
- V.T.V.M., 0-150 Volts D.C.
- V.T.V.M., 0-750 Volts D.C.

NET PRICE **\$10.40**

COMPANY

DEPT. RW2
136 LIBERTY STREET
New York City

FOR MODERN AND EFFICIENT TESTING . . .

The series 840 tester provides complete facilities for obtaining all necessary measurements including a wide variety of ranges. The radio technician will find this instrument ideally suitable for servicing radio receivers, transmitters and P.A. systems. Although nominally priced, the same well known Precision quality and standard of accuracy prevails as incorporated in higher priced Precision testing equipment.

SERIES 840L

A.C.—D.C. VOLT—OHM—DECIBEL—MILLIAMMETER

including a

2500 VOLT A.C. and D.C. RANGE and a 1000 M.A. RANGE

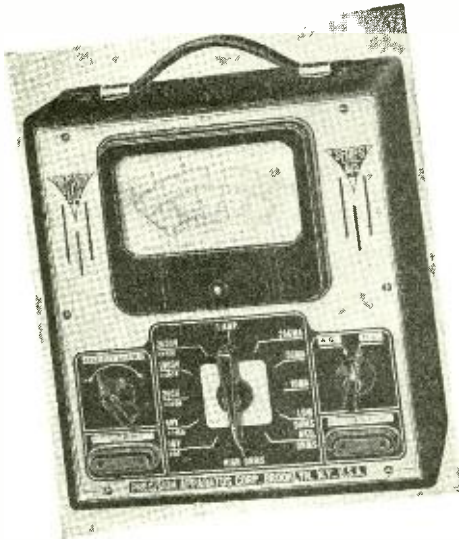

SPECIFICATIONS

Five A.C. and D.C. voltage ranges at 1000 ohms per volt:
0-10; 0-50; 0-250; 0-1000 and 0-2500 volts.
Four D.C. current ranges:
0-10; 0-50; 0-250; 0-1000 MA.
Three resistance ranges:
Low ohms (shunt method) $\frac{1}{4}$ to 400 ohms;
20 ohms center.
Medium ohms 0 to 1 megohm.
High ohms 0 to 10 megohms.
Note—Provision for mounting ohmmeter power supply (4½v. and 45v. batteries) on inside of case. No external connections necessary.
Five Decibel ranges from -10 to +63 DB:
0 DB; +14 DB; +28 DB; +40 DB; +48 DB.
Five output ranges:

OTHER FEATURES:

Large 4" x 4½" square type meter, base sensitivity 400 microamperes, D'Arsonval movement 2% accuracy; dual adjust ohms control; leatherette covered wooden case with carrying handle. Compact size 7½ x 8½ x 4.
Note—Series 840L and 840P are not furnished with batteries and test leads.

Net \$19.95

Accuracy guaranteed by use of wire wound shunts of 1% tolerance and matched resistors of 1% tolerance.

Endorsed and used by leading engineering concerns, broadcast stations, institutions, amateurs and servicemen.

Complete line of "PRECISION" testing equipment available. See these and other instruments in our store.

SERIES 840P

Incorporates same specifications as 840L but housed in attractive black leatherette covered portable case with removable cover. Size 9 x 10 x 6.

Net \$21.95

HARVEY RADIO COMPANY

103 WEST 43RD STREET

W2GWE

W2IJL

W2KWY

NEW YORK, N. Y.

W2KXP

Complete RADIO TRAINING for \$5

Regular \$39.00 RADIO TECHNICAL INSTITUTE Course



AN UNUSUAL OFFER

We have obtained a limited number of R.T.I. radio servicing courses, that have regularly sold for \$39.00, and offer them to you for only \$5.00. These are the latest radio courses, complete in every detail, with all supplementary material.

Radio is the present-day opportunity field. Hundreds of men with no special talents have studied Radio Servicing for a short time and are now making twice and three times as much money as before. R.T.I. unique radio training brings rich rewards; you can get ready quickly, inexpensively, easily, and in your spare time for a good job.

ACCEPTED BY INDUSTRY

Forty large radio concerns have helped to prepare the R.T.I. course. Just think what this backing by the radio industry means to you.

R.T.I. training gives you the practical information you will need when you are on the job. Hundreds of diagrams and illustrations help you to clearly understand important facts. You will pass quickly from lesson to lesson and in a surprisingly short time you will be ready to do real radio servicing. This is your chance to obtain this excellent course for only \$5.00.

COMPLETE IN ALL DETAILS

No special previous education or experience is needed. R.T.I. course will give you all the training you need. The lessons are clear, interesting, easy to master and use. Fellows who knew nothing about radio before taking the R.T.I. courses are now the leading servicemen in their communities. And you can now obtain this training at the special price of \$5.00.

YOUR GUARANTEE

You are completely protected. We guarantee these courses to be the identical courses sold and advertised by the Radio Technical Institute at \$39.00. References: Liberty National Bank, Chicago.

THREE COURSES IN ONE

R.T.I. course is really three essential courses in one. You get training in (1) Practical and Applied Radio; (2) Fundamentals of Radio Principles, and (3) Advanced Specialized Training. This is the training that will place you above the average radio servicemen—and you can obtain this training now for only \$5.00.

COMPLETE SERVICING COURSE



The R.T.I. has gone out of business and we obtained a quantity of their latest 1937 courses. We offer to you (while 420 courses last) the complete course with all supplementary materials for only \$5.00. We further guarantee the courses to be identical in every respect to the ones sold and advertised by the Radio Technical Institute for \$39.00. This is the best buy in a radio education. Take advantage of our special offer today. Get into Radio to make more money.

BEST RADIO EDUCATION

There are over 28,000,000 radio sets in use. Over 4,000,000 auto radios alone.

You should cash in on this gigantic money market. Well trained radio servicemen are badly lacking. The R.T.I. easy, practical course will pave the way to your success in Radio Servicing. And you can get this training now for only \$5.00.

OVER 750 ILLUSTRATIONS

Every important fact, part, and circuit is illustrated and explained from a practical point of view. With the R.T.I. advanced training you will understand complex modern radio circuits. You will also get training in Public Address work, photo-cell, and Television. Order the course today at the bargain price.

TELLS HOW TO USE INSTRUMENTS

From the very start, you are introduced to practical servicing equipment and practices. You are told how to open your own service shop or radio store. Lesson 15, "The Radio Servicing Business," will give you many practical ideas and hints. The course is so planned that you will be able to earn spare-time money before you have reached your tenth lesson. The special \$5.00 price of the course may be earned in a single evening's work.



The training is complete. Many servicemen have found that R.T.I. training is excellent for brush up and study of modern servicing methods. You receive training from the simplest radio facts to the most complex set alignment.

LATEST DATA



Yes, in the R.T.I. course you will find complete explanation of A.V.C., A.F.C., 20,000 ohm per volt meters, sound feed-back . . . every possible fact you must know to be the best servicemen. You will get a real radio training. One of the BEST radio courses is yours for only \$5.00.

LIMITED QUANTITY

Hurry your order to us today. There are but 420 courses at the special bargain price. You are completely protected with our guarantee. Send total remittance with order, or just one dollar for deposit. Postal money orders, checks, currency, unused stamps accepted.

SUPREME PUBLICATIONS, Agents 3727 W. 13th Street, Chicago, Ill.

Please send the complete R.T.I. radio course at the special \$5.00 price.

- I am enclosing \$5.00, send prepaid.
- Send C.O.D., I am enclosing \$1.00 deposit.

NAME

ADDRESS

RADIO WORLD

SERVICING, MEASUREMENTS AND DEVELOPMENTS

Sixteenth Year

ROLAND BURKE HENNESSY
Editor

H. J. BERNARD
Publisher

HERBERT E. HAYDEN
Advertising Manager

Table of Contents for FEBRUARY, 1938

Signal Generator Leakage 10 <i>Its Causes and Some Reduction Methods</i> By H. J. Bernard	Economical Push-Pull Audio 34 <i>Used with a Phase Inverter Tube</i> By Walter G. Wyndham
An A-C Ohmmeter 18 <i>Tube Rectifier and Filter Replace All Batteries</i>	Better Tubes, Better Performance 36 <i>Short Waves Particularly Affected</i>
180° Shadow Angle with Ray Tube 19 <i>Tuning Indicator Range Extended by New Circuit</i>	Editorial: Fair Trade Practices 38
Transmission Lines at High Frequencies 20 <i>Use as Transformers Included</i> By W. P. Mason	Decibels Explained Simply 39
Wanted: Instrument Rectifier Tube 23 <i>It Should Be Free of Idling Current</i>	Phototube Operation 40 <i>Both Vacuum and Gas Types Considered</i>
Not Wanted: Door Prizes at Service Meetings 25	A Volume-Limiting Circuit 44 <i>Enables Doubling Transmitted Power</i> By O. M. Hovgaard
Constants for Quality A.F. Heater Tubes 26 <i>Resistance Coupling, 150 Ma</i>	Electrolytic Condensers 48 <i>Their Theory, How They Are Made, Tested and Used</i> By Paul McK. Deeley
They Still Build T-R-F Sets 30 <i>A Standard Broadcast Band Circuit</i>	Sylvania and Magazines Victimized 52 <i>In Blasphemous Advertising Hoax</i>
Considerations Affecting Tube Testers 32 <i>How to Determine the Worth of a Tube</i> By M. N. Beitman	Radio University 58 <i>Technical Questions Answered</i>
	Jack Benny Leads 62 <i>In Two Separate Radio Polls</i>

Vol. XXX, February, 1938. No. 11. Whole No. 713. RADIO WORLD, published monthly by Hennessy Radio Publications Corporation, 145 West 45th Street, New York, N. Y. Editorial and executive offices, 145 East 45th Street, New York, N. Y. Executives of RADIO WORLD: Roland Burke Hennessy, editor and business manager; H. J. Bernard, publisher; Herbert E. Hayden, advertising manager. Officers of corporation: Roland Burke Hennessy, president-treasurer; Roland Burke Hennessy, Jr., vice-president, H. J. Bernard, secretary. Entered as second-class matter March, 1922, at the Post Office at New York, N. Y., under Act of March 3rd, 1879.

SUBSCRIPTION RATE

Price 25 cents per copy. Subscription \$2.50 per year (12 issues); \$1.25 per six months (6 issues); postpaid in the United States and Possessions; \$3.00 per year, \$1.50 per six months, postpaid in all other countries. Remittance for foreign subscriptions should be by International money-order (postal or express) or draft against or discountable at New York bank.

RADIO WORLD is distributed by the American News Company and its Branches

TAKE THE *Easy* WAY TO LEARN RADIO

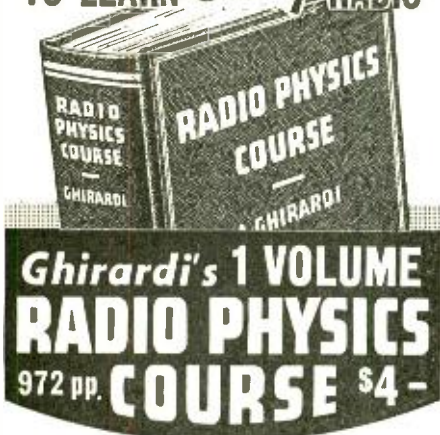

YOU, too, can pick up RADIO quickly—if you will let Ghirardi help you. In almost no time at all you'll completely master the subject, because Ghirardi's 972-page home-study RADIO PHYSICS COURSE is such easy reading, so simple, so absorbing, and so exciting that you won't lay it down from the time you start with simple electrical theory to where you wind up with television under your belt! Ghirardi makes everything about RADIO, ELECTRICITY, SOUND—and even TELEVISION—as simple as A B C! That's why more radio schools and students use it than any other radio book in the world. They say it's the best there is—at any price!

What You Will Learn from This Book!

Sound, Speech and Music . . . Electrons . . . Electric Current . . . Electric Units and Circuits . . . Resistance . . . Ohm's Law . . . Batteries . . . Magnetism . . . Electromagnetism . . . Transformers . . . Inductance . . . Condensers . . . Alternating Current Circuits . . . Filters . . . Electrical Measuring Instruments . . . Radio Waves and Radiations . . . Broadcast Stations . . . Receiving Equipment . . . Vacuum Tubes . . . Radio and Audio Frequency Amplification . . . Superheterodynes . . . Loud Speakers . . . Battery Operated Receivers . . . Power Supply Units . . . Electric Receivers . . . Automobile and Aircraft Receivers . . . Phonograph Pickups . . . P. A. Systems . . . Short-Wave Receivers . . . Photo-electric Cells . . . Television . . . Antennas and Grounds . . . Testing and Servicing Receivers . . . Sound Motion Pictures . . . Appendixes . . . 856 Review Questions for Self-Study . . . AND LOTS MORE!

Quick Action Gets You Started!

The 506 illustrations alone are worth much more than the amazingly low price of only \$4 for the entire book! When are you going to start? Don't put it off—get going—learn RADIO NOW. It's easy from this one great book! Remember every penny of your money back if not fully satisfied! Books sent postpaid anywhere!

Snip this Coupon out!
-MAIL IT NOW!

To: RADIO & TECHNICAL PUBL. CO.
Dept. RW-28, 45 Astor Place, New York
Enclosed find \$4. Send me RADIO PHYSICS COURSE at once, postpaid (Foreign \$4.50).
Send me a free circular describing this book.
Name _____ State _____
Street & City _____

MONEY-BACK GUARANTEE!



THESE 2 BOOKS GAVE ME 18,000 HOURS OF SERVICING EXPERIENCE

What a Combination!

Every word in Ghirardi's two big servicing books brings you the results of thousands of hours of tried and tested servicing experiences and knowledge of others—to save your own time.

Handy Time-Saver

For example, the big loose-leaf DATA BOOK gives you the Case Histories of 1,500 receivers—the biggest collection in the world! Every one of them means anywhere from 10 minutes to 10 hours saved on a job. And then there's a list of superbetter receiver I.F.'s over 6,000 of them! For alignment work. You'll also get Auto-Radio Installation and servicing data for all cars, and loads of shop & job data in this quick-and-reference book that has a regular Supplement Sheet Service to keep it always up-to-the-minute.

The Companion volume, MODERN RADIO SERVICING, is laid out to explain fully every aspect of modern servicing practice—all about test instruments, quick trouble-shooting methods, repair methods, etc., etc.—written in Ghirardi's famous "Easy-to-Understand Style" with loads of diagrams and illustrations (706 of them!).

Order the books NOW—and tomorrow you'll have complete command of your profession within your grasp. Fill out the coupon below and mail it. You don't risk a single penny. Sent Postpaid Anywhere!

MODERN RADIO SERVICING & RADIO FIELD SERVICE DATA BOOK
1800 Pages, 813 illus.
Both Books for \$6



MODERN RADIO SERVICING

Radio & Tech. Publ. Co.
Dept. RW-28
45 Astor Pl., N.Y.

Here's \$6 for MODERN RADIO SERVICING and RADIO FIELD SERVICE DATA (including the January and June 37 Supplements to Data Book) postpaid. Send free literature

NAME _____
ST. and CITY _____
STATE _____

ORDER NOW! MONEY-BACK GUARANTEE!

THE CONSPIRACY TO PERPETUATE GENERATOR LEAKAGE

MANY of the service oscillators, or signal generators, in use are of the "universal" type, i.e., work on line a.c. or d.c., and suffer from considerable leakage. If a receiver is turned on anywhere near the signal generator, and the generator is going, a signal can be delivered to the resonant receiver. If the receiver is tuned to a station, and the generator is unmodulated, there will be an audio sound,

If the receiver is not shielded much there will be coupling even if there is no antenna wire on the set, although this coupling may be very weak, falsely making the leakage appear to be low, since the degree of leakage is not changed, and has to do with what the generator ejects, rather than what the receiver accepts. For instance, a dead set is not proof that a generator is leak-proof.

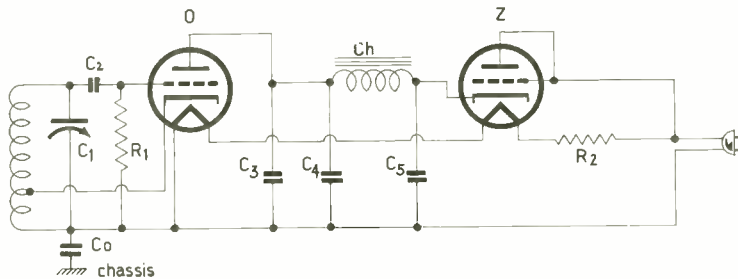

FIG. 1
Circuit used for noting leakage. The device was enclosed in an iron box, and chassis made conductive to the box. The values of constants are given in the text.

or beat, when the two frequencies are close together. If the receiver is not tuned to a station, but the generator is modulated, the modulation frequency will be heard in the receiver. Yet there is no intentional connection between generator and receiver, hence the unintentional coupling is due to leakage.

ANTENNALESS RECEIVER

It is not necessary that the receiver and the generator be tuned to the same frequency, only that one frequency be a multiple or submultiple of the other. For instance, the receiver may be adjusted to 1,000 kc, and the generator to 100 kc, and there will be a response, due to the tenth harmonic, or multiple, of the generator frequency. Or, stating the same situation differently, the generator frequency is the tenth submultiple of the frequency to which the receiver is adjusted.

In the antennaless instance generator submultiples of the intermediate frequency may cause responses, especially if the i-f channel is high-gain. This is especially true if there is sufficient length of unshielded wires leading to overhead grids in the receiver, so that the i-f channel has a few small antennas for pickup.

Perhaps the responses due to harmonics are the most confusing, because so often, in fact nearly always, unwanted. Leakage at the fundamental level, when generator frequency equals the resonant frequency of the receiver, could be pardoned. The reason for making such allowance is not only that the leakage problem is hard to solve, but that responses from fundamentals are always desired, and if there is some leakage, and none on harmonics, there would be no confusion.

However, the situation calls for a closer solution than that, even though elimination of

By H. J. Bernard

the harmonics is itself rather an ideal than a fact.

On the other hand, the question of leakage is always a relative one, in practice, since there is bound to be some leakage anyway, and the question is, how much is tolerable?

WHERE LEAKAGE INCREASES

Also, it is most difficult to restrain the leakage at the higher frequencies (short waves) and a leakage test for fundamentals should be made at some high frequency, provided that the oscillation intensity is not so low, due to circuit losses accumulating as frequency increases, that weakness of the oscillation is being measured, rather than smallness of the percentage of output ascribable to leakage.

The readiest way to reduce the effect produced by harmonics is to have a linear oscillator. Such an oscillator is not too difficult to establish, so far as linearity is concerned, when one considers the characteristic curve of the tube, but the sad part is that some harmonics get out nevertheless, although it is easy to suppress half of them, in that even harmonics could be imprisoned by a push-pull arrangement, and only odd harmonics would be present, and these need not be excessive.

There is much more to the problem than the linearity of the oscillator, for some strength of output is preferred, and when the strength is originally obtained from the oscillating tube, various parts in and about the tube serve as effective antennas. Mostly the trouble has been ascribed to the line cord, in universal type oscillators, as if, say, a battery-operated device would be free of the nuisance.

In an effort to ascertain some of the factors that contribute to leakage the rectifier B supply was substituted with a B battery and still the leakage persisted. In fact, the percentage of leakage was about the same, even though the B battery voltage was only half that for the rectifier's filtered output.

DECEIVED RESULTS

It should be remembered, if any comparisons are being made by the beat method, that reduction of leakage can not be reliably measured at the receiver without recognition of the fact that the beat is due to the sum of two voltages, one from a station, and the other from the generator, both amplified in the set. Hence if the station's contribution is large compared to the leakage, even if the leakage is greatly reduced the change in the measured result may not be insignificant. The leakage therefore should be measured by the modulation method, and no station used for beating with the generator's carrier.

It was therefore established that the B supply did not contribute any more to the trouble whether it was of the rectifier, or battery type, and even very large capacity condensers, considering the generator frequencies, did not help, no matter where placed, whether across the line, or from one side of the line to other experimental points, not even the two-section capacity filters so necessary in receivers hav-

ing power transformers without static shields. If the line cord on the B side was not seriously to blame, then what about the heater side? When the series heater method was re-

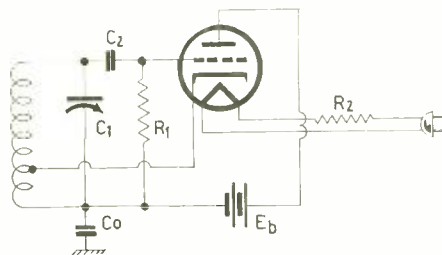

FIG. 2

Nothing substantial was gained by replacing the rectifier in Fig. 1 with the B battery E_b shown above, since leakage was about the same.

placed with a filament transformer, there was no change worth mentioning, for still the leakage persisted.

THE CHASSIS AS AN ANTENNA

Nearly always the generator is built on a metal chassis, and enclosed in a metal box. The box may be intended for grounding. Since one side of the line is grounded, a large capacity condenser from chassis to one side of the line caused a reduction of leakage due to harmonics. Such a condenser is therefore included as a matter of course, being principally of some help on harmonics, though not much use on fundamentals. It is by no means a solution, although if one uses as test a receiver of low sensitivity, the reduction appears more successful than it is. Since most sets one has to service will be sensitive superheterodynes, and not small t-r-f receivers, how much the large condenser between line and chassis helps will seem to be greatly affected by the set itself. This merely shows that the proper criterion is not being applied. The final reduction would have to be much more effective to be of any real value. All tests must be made on sensitive sets, with antennas connected.

The various parts about the oscillating tube, and the tube itself, have been mentioned, along with the chassis, and these contribute the most serious part of the problem. If there is radiation from various sources, naturally it is difficult to introduce any one method in the hope of stopping a multiplicity of outlets.

That the chassis itself plays a serious part in contributing to the nuisance is evidenced by the fact that the large capacity condenser, say, 1 mfd., between chassis and one side of the line, helps encouragingly. Therefore the chassis is proved to be at an elevated r-f potential, the condenser tends to reduce this potential, so

(Continued on next page)

(Continued from preceding page)

much so that the frequency of oscillation is not changed beyond the audio realm at all when one touches the chassis, assuming radio frequencies no higher than 5 megacycles. To say it differently, coupling between chassis and oscillator grid is reduced. But the radiation

at least as good as copper would be required, and if heavy-gauge copper, would naturally be very expensive, and not a full remedy, either.

The tuning coil itself may not be individually shielded, and thus the chassis obtains some potential from that coil, which in one way or another, is fairly close to the chassis or box.

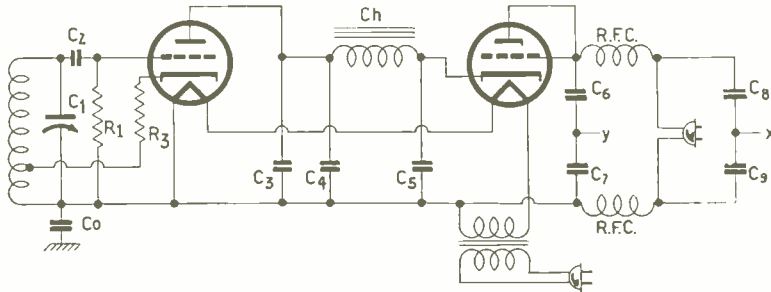

FIG. 3

A filament transformer was substituted for the direct method of supplying the heaters, with no reduction of leakage. Condenser-choke filters were tried, with x and y to various points, to no avail.

from the chassis, which may be compared inversely to chassis pickup that causes troubles in auto receivers, is not eliminated by the simple condenser expedient.

GROUNDING THE CHASSIS

While considering the chassis, and the box that becomes electrically a part of it, because of conductive contact, it is natural to bring up a suggestion that the chassis be grounded. But it is hard to find a ground potential, just as hard, perhaps, as to stop the leakage entirely. A ground may be assumed to mean a point in earth from which all the increment of potential proceeds, hence ground possess zero r-f potential. But if such a condition actually existed, it would be at one point only, and any wire brought from that point would have an ascending potential, until the end of the wire to be connected to chassis may have a higher potential than the chassis itself. Meanwhile of course the so-called ground lead has become partly antenna, and picks up oscillation from the generator, and there may be unison in phase, so that there is more chassis radiation when the chassis is "grounded" than when the ground lead is omitted. The return wave finds its course mostly by some route other than along the intended ground conductor. And the so-called ground wire may aid in sending current through that other path, instead of preventing such diversion.

So a ground lead, as applied practically to oscillators, need not be considered of great assistance, especially if the oscillation intensity is rather high, as it is likely to be in a Hartley circuit, or in any other circuit where the feedback coupling is fairly tight.

COIL AND TUNING CONDENSER

If better shielding material than iron is used for radio frequencies some shield effect due to the metal box would be expected, but a metal

The grid leak develops about it a rather strong field, and though this is seldom considered, it, too, becomes one of the multiple feeds to the chassis. The tuning condenser has a relatively large total flat area, even if only the stator plates are considered, and these will radiate, and a shield around this condenser could offer some aid, but without full means of grounding the shield, full shielding is impossible. Just as the leakage percentage may be expected to increase greatly as the frequency is increased, so the ineffectiveness of attempts at shielding increases as the oscillation intensity increases in the self-excited oscillator.

The tube itself is not immune, whether of the glass or even of the metal type. The grounding difficulty is general, and the fact there is metal around an object does not mean at all that it is shielded. A true ground potential must be found, and since it does not exist on the chassis, and perhaps can not practically be obtained from the outside to fulfill all requirements, it follows that the so-called shields well may augment the leakage, instead of reducing it.

USE OF A TUBE SHIELD

This actually took place when a tube shield was put over a triode oscillator (6J5G), very markedly so when the tube shield was not connected anywhere, while when connected to chassis, or one side of the line, there was still the same leakage as originally, with the cover of the generator box removed. Attaching the cover would increase leakage a little, unless the cover became proximate to some coil of the range in which tests was being made, when the resultant losses in the coil reduced the intensity of oscillation but not, however, the percentage of leakage.

Fig. 1 shows the general circuit used in making tests. C₀ is the 1 mfd. condenser connected between chassis and one side of the line.

C_1 is the tuning condenser, C_2 the .00025 mfd. grid condenser; C_3 is .1 mfd. paper dielectric to support oscillation otherwise lacking at frequencies above 25 megacycles or so; C_4 and C_5 are electrolytic filter condenser, 8 mfd. each; while R_1 is the grid leak, 50,000 ohms; R_2 is the line cord resistor, 350 ohms, 30 watts; O is the oscillator tube and Z is the rectifier tube.

In Fig. 2 is shown the B battery replacing the line supply rectifier. Since the leakage was not reduced to any noticeable extent, the rectifier B supply was freed of suspicion of being in any serious way related to the large leakage trouble. In Fig. 3 a filament transformer is shown replacing the series line feed, and again, since there was nothing remarkable about the change in leakage conditions, the line in general was given a clean enough bill of health. It is not argued that no leakage takes place through the antenna effect of the line cord,

This is done on the theory that the main source of leakage is the line cord, and that if the r-f voltage is cancelled out in this way, there will be no leakage. The method has theoretical soundness, but in practice it is necessary to stop the leakage from all other sources, too, and they are rather numerous. In Fig. 4 is a notation of eight of the principal causes of leakage.

RATHER PURPOSELESS

If the chassis and associated parts, some of which are accessible for union to a common point, contribute greatly to leakage, then for at least a single setting of the tuning condenser on a single band, the chassis has a definite elevation of potential. An attempt might be made to find some other point in the feed back loop to which to return the plate bypass condenser, as suggested in Fig. 5. When the

FIG. 4
Notation of the eight principal causes of leakage: 1, tuning coil; 2, chassis itself, which behaves as an antenna plate; 3, both stator and rotor of tuning condenser; 4, the tube; 5, the grid leak; 6, the grid condenser; 7 all the associated wiring, and 8, the line cord.

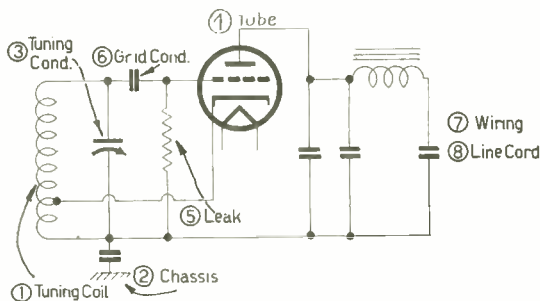

but admittedly some gets out that way, especially since the resistance wire in the line cord is inductively wound, but it is maintained that the trouble is far more serious than confinement to just that simple cause. If there were nothing to the problem other than the line feed there would be nothing hard about a solution.

INCLUSION OF FILTERS

Various methods are used in more elaborate oscillators to safeguard against leakage, and in the precision apparatus made for set manufacturers and others, costing up to \$1,250 or so, leakage is really reduced to almost nothing. Either batteries or a.c. may be used, provision being present for both means, but leakage is nearly nothing one way and the other. That also would indicate that leakage is not so closely related to the power supply in that example either.

Such filters could be put into the universal type oscillator that is made to sell at a price to servicemen, and some manufacturers do aid the situation to an extent by such provision, but there is still some leakage. One position used is in the line circuit, just as it comes into the oscillator box. Instead of making any direct connection, the line current is passed through two coils, one on each line side, each about 1 to 2 millihenries inductance, and the coils are rotated in respect to each other, until the phases are as nearly opposite as possible.

potentiometer P is 5,000 ohms, a point of minimum leakage is found by adjustment of the slides, but turned out to exist when the slider was connected to the chassis side of P . So there was no purpose in including P at all.

Or, considering the chassis itself, instead of connecting it to the one side of the line through a condenser, suppose the free side of the condenser were connected instead to a higher r-f potential, as found along the cathode-to-B minus drop, Fig. 6? The situation becomes worse, because if the chassis at start has a certain elevation of r-f potential, then it will have a higher one, the more the chassis is moved electrically toward the highest potential in the oscillating system, which may be assumed to be the grid, in the circuit shown.

What might be of some help is to find a potential in the opposite direction, just equal to the chassis r-f potential, though of opposing sign, and find the correct level by proper choice of extra turns, or by excessive turns, and adjustment of potentiometer P in Fig. 7.

The fact that the chassis and box are a serious contributor to leakage is further exemplified by the fact that laying them on a wooden table, three feet removed from the nearest piece of external metal, resulted in a marked reduction of leakage. So no shielding seemed to turn out to be to better shielding than lots

(Continued on next page)

(Continued from preceding page)
of shielding! Or, shielding that doesn't shield,
radiates more than it shields!

SUGGESTION FOR CONSTRUCTION

The multiplicity of the leakage sources renders solution difficult, and while total elimination of leakage can not be expected so long as you have an oscillator that generates reasonable amplitude at least, any remedy that takes all the sources of trouble as a group and addresses a single remedy could go a great way. Then subsidiary remedies are applied, also.

In view of the experiments already reported, which disclose the peril of metal pieces close to the oscillatory system, it is preferable to build the oscillator on an insulator, like wood or Bakelite or heavy fiber, use plenty of space, have connecting wires clear of one another as much as possible, keep the grid leak and grid condenser well spaced apart, the condenser preferably above the chassis, the leak below; and use a copper or aluminum box, purposely of very generous proportions, so that nothing metallic in the oscillator proper is in any sense close to the box. There are at least three

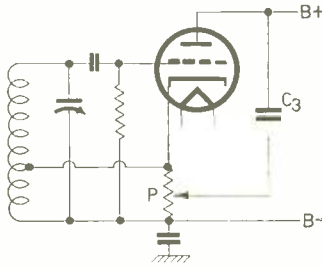

FIG. 5

Of no avail was return of the plate bypass condenser to some elevated r-f potential. In fact, leakage naturally became worse the higher up the pointer of P was moved.

points where the line connection to the 1 mfd. condenser may be made, and the other side of this condenser is connected to the box at the point where it will do the most good, the line side used being the nearest one, in the light of the special location of the condenser.

With the box thus generously sized, it is possible that a short thick wire (preferably No. 14) from adjacent cold-water pipe to the chassis, will do some good, and if so, include this connection as a ground. However, on occasion the connection may, as before, make the situation worse rather better, or, to add to the gaiety, the connection proves its value on some bands, and its vice on others, and so grounding in this way could be included as part of the switching, the condenser cut in for the helpful bands and out for the helpless bands.

BOX WITHIN A BOX

Another expedient, if the cost and time are not bothersome, is not to rest content with the box just described, but to connect it as stated, and then enclose the whole in another

box, not insulated from the first, and connect the external ground only to the outer box, whereupon ground will be noticeably effective on all bands, save possibly the highest frequency range, say, 7-25 mc.

So far the Hartley circuit has been discussed exclusively, because it is the most popular. However, other circuits have merits in the light of low leakage, for instance, the Colpitts, Fig. 8. This is by no means free of leakage trouble, but the inherent leakage for the same oscillation intensity as in the Hartley is much less, probably due to the balanced nature of the circuit. C_1C_2 is a two-gang condenser, with equal sections. RFC is an r-f choke, 2.5 millihenries, or more. C_4 is a mica condenser, only large enough to insure oscillation at the lowest frequency to which the circuit is to be tuned, but not excessively larger. R_1 is 50,000 ohms. Ch is the B choke, C_3 1 mfd. paper condenser, while C_6 and C_7 are 8 mfd. electrolytic condensers.

The suggestion has been made that fairly substantial outputs are required of oscillators, yet the need arises only when one is working on a set that is so far out of alignment that

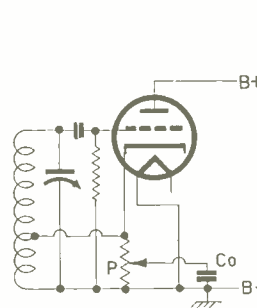

FIG. 6

If the chassis is at a somewhat elevated r-f potential, using a large capacity condenser C_0 to find an equal but opposite potential, along the oscillation route seems promising. But the elevation produced by the circuit at left is cumulative.

a husky input is required, to produce any response at all, and then by tuning the circuits, as sensitivity is improved, the input is reduced by using the generator's attenuator (volume control). Especially if a.v.c. is present in the receiver must the generator output be made very low, because otherwise resonance would be masked, as a.v.c. holds the output relatively constant for resonance and considerably off resonance on both sides, so proper guide would be absent.

PERIL OF OSCILLATION STOPPAGE

If the oscillation intensity is originally kept low, the leakage will decrease much more than proportionately, until one might feel entirely satisfied that leakage was the irreducible minimum.

Yet, in maintaining a weak oscillator, care must be taken not to run risk of oscillation failure. A good way to check is that the grid current, as measured on a microammeter in series with the grid leak (between B minus and leak) should read 20 microamperes or

more, with .05 meg. leak, and preferably not vary greatly over the tuning range. This test may be used in finding the best point for locating the coil tap for each band in a Hartley

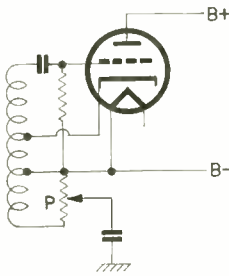

FIG. 7
The direction in which to move is suggested by the diagram at left for potential to chassis opposite but equal to normal.

oscillator. From band to band the grid current average will vary much, and perhaps it is asking too much that an attempt be made to have the grid current about the same for the same condenser setting on all bands, as well as about the same for all condenser settings on all bands. The Hartley is rather difficult to handle on this constant-current basis, so a variation of 2-to-1 may be considered passable. Better than that, say, 1.5-to-1 may be accomplished with pains.

On the higher frequency bands, since the grid current becomes less, other factors equal, on account of diminished intensity, measure the highest-frequency band first (smallest coil), and if oscillation is present all over the band, indicated by grid current readings exceeding 20 microamperes with .05 meg leak, tap the rest of the coil so that about the same grid current obtains, for the same condenser setting used in the test.

FEW FEEDBACK TURNS

If the variations in grid current over the highest frequency band are not enormous they will not be enormous over the lower frequency bands.

Do not be surprised at the few turns above return end of the coil at which the tap is to be taken, and remember that nearly all the condenser capacity, or all of it, should be used in the first oscillation test, because with the high capacity in circuit the oscillation is most

difficult to start, assuming there is at least some trimmer capacity, and if no such trimmer is included do not use the last few degrees of condenser rotation, near minimum, for total inductance selection or calibration.

Behind the grid current suggestions also is the idea that if the grid current is actually held constant, the output will be of constant amplitude, and therefore the oscillator will be stable in amplitude and frequency. When the oscillator has such stability it falls within the linear class, and its harmonic content, although not insignificant, is far less than when no attention is paid to stabilization. That is a good way to help reduce harmonics.

Since there will result a weak oscillator, and since there may be some justification for requiring much higher output, it is feasible to include an amplifier. Thus a small load is put on the oscillator plate circuit, a stopping condenser is used, and a grid leak to B minus closes the grid circuit of the negatively-biased amplifier tube. The gain in the amplifier can be held fairly constant by having the stopping condenser large (.006 mfd. or higher capacity) and the plate load an inductance chosen so that at full or nearly full capacity on the highest frequency band the output amplitude is about the same as at the same condenser setting for other bands. The attenuator naturally would be in the amplifier tube plate circuit, thus safeguarding the oscillator itself from much detuning effect due to working this control, and the measurement is made of amplifier plate current change.

The advantage of the amplifier system is that the weakness of original oscillation is preserved, and the intensity of a violent oscillator is enjoyed, without more than insignificant increase in the leakage beyond what it would be if the amplifier were absent.

A PRACTICAL CIRCUIT

While the suggestion about juggling the phases, until they are equal and opposite, has been made, it is not of any great practical value, because any solution would have to be of simpler and more permanent application than that. Nevertheless, the plate circuit is 180 degrees out of phase with the grid circuit, and a condenser of some value that tends to bring the

(Continued on next page)

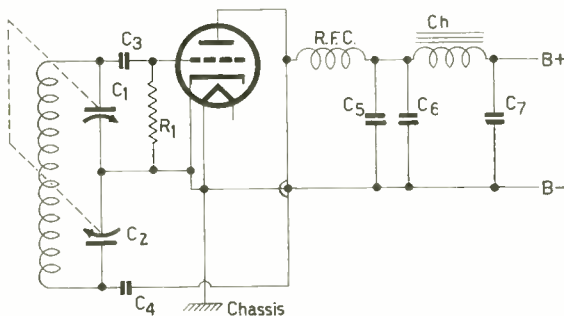

FIG. 8
The Colpitts oscillator is a balanced circuit and gives smaller percentage of leakage than most other oscillators. Make the plate lead to C4 hop over the B minus lead, as indicated, and neglect the dot.

(Continued from preceding page)

chassis a little nearer to the plate potential will be of some value. Such a value in a particular instance was found to be .1 mfd., although for different setups a different value might prove more beneficial.

The diagram of the circuit is shown in full in Fig. 9. The tuning condenser is .0004 mfd., and the five coils are selected on that basis, segregating the frequencies as shown for the five bands, A to E, to cover 120 kc to 40 mc. inclusive.

Modulation is obtained from the line frequency, and is adjustable, from zero to what-

voltage drop across the choke, though the choke had 2,000 ohms d-c resistance, was only a few volts.

THE OUTPUT CONTROL

A queer sort of symbol to the right of the 6J5-G oscillator tube is intended to convey the idea that a metal plate is moved nearer to the tube for increase of output voltage, until right close up against the tube output is maximum, and withdrawal accomplishes reduction of output. This is an innovation that an experimenter will perhaps enjoy trying, although in the absence of a commercially-made device for permit-

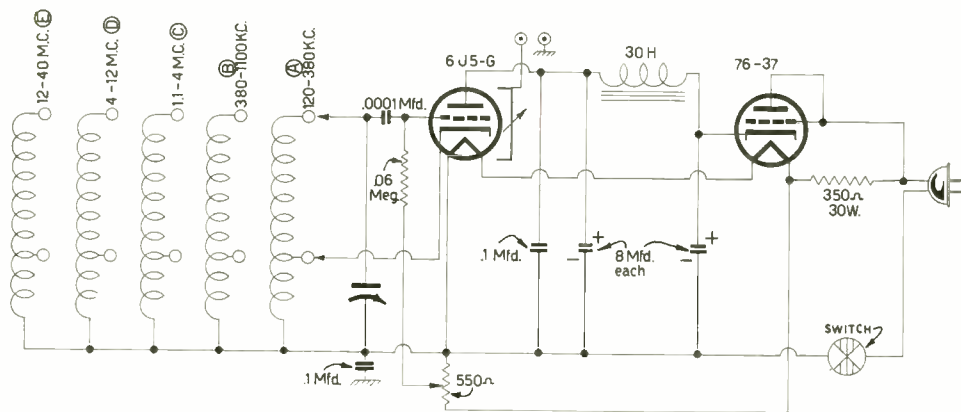

FIG. 9

Complete diagram of a signal generator with low leakage. The line frequency is used for sine-wave modulation. The phase of the leakage radiation from chassis was that of the grid circuit, and .1 mfd. from plate to chassis partly neutralized this. The queer symbol to right of tube is the attenuator.

ever percentage obtains. For a sizeable percentage, much less than 50 per cent., however, the drop across the two heaters may be utilized, as shown, whereas for smaller maximum the drop across one heater alone may be used instead. At any rate, the source of about 12.5 volts or so, as appears from the diagram, is not effective to that full voltage extent on the oscillator, due to the leak resistance.

PERCENTAGE MODULATION

The percentage modulation will vary, band to band, and even over a particular band, due to change in the oscillation intensity. However, it will remain constant for any one r-f and a-f settings, and the only object of making the percentage adjustable, and letting it remain relative, i. e., not calibrated, is to permit selection of the degree of tone most suitable to the operator.

Instead of the usual resistor used as a B filter adjunct for economical reasons, a choke of 30 henries is designated. This is a value readily obtainable. The one actually used had an inductance of 42 henries at 20 milliamperes, and since nothing like 20 milliamperes flowed, the operating inductance was much larger. At any rate, the filtration was excellent, and the

ting such control, it is unlikely the method will find application in factory-produced oscillators.

It has the advantage of permitting a considerable change in output, without changing the frequency of the oscillation, and without loading the circuit into which it works, either. How little can be taken out at minimum setting depends largely on how small the leakage, for if leakage were reduced to zero, output could be made zero by adjustment of this control, by moving it far enough away from the tube.

A simple rotating plate will do the trick, consisting perhaps of a sheet of copper or aluminum 3 x 2 inches, although more effective control is attained when the device is rigged up as a sort of cap to fit over the tube, something as a tube shield would, and the operation consists of withdrawing the shield (which is not grounded and not operating as a shield) to reduce the output.

The importance of the location of the oscillator and all "hot" parts as far away from metal as practical has been stressed, and Fig. 9 shows how this is done. The chassis layout, seen from top, is at left. The 6J5-G is also at left, but toward the rear. The hole for the tube is oversized, therefore the tube can be sunk through this hole for half the height of the tube, where-

upon the socket, which is held by Z brackets, receives the tube prongs, and everything about the tube is kept as far as practical from metal. This easily includes the grid leak, which is connected between grid of tube, which has outlet beneath the chassis, and one side of the line. This is the side of the line which is also one side of the heater of the oscillator tube.

The pictorial diagram shows how the tuning condenser frame is insulated from the line and from the chassis, whereas the insulation of the line from the chassis is itself accomplished simply by not connecting the line to the chassis. However, there is a .1 mfd. condenser between the line and chassis and when a.c. is used—since this device works on both a.c. and d.c., although it does not modulate on d.c.—a small static discharge may take place if one touches the chassis.

The coils, dial and tuning condenser for the oscillator are commercially obtainable, the dial reading in kilocycles and megacycles, as suggested in Fig. 9.

Treaty Expected to Bring Station Frequency Changes

Washington

A treaty of North American nations for operation and regulation of radio broadcasting is expected to develop from the Inter-American Radio Conference recently concluded at Havana. Within a few years there would result changes in frequencies of many American stations. The treaty, it is expected, will be signed by Canada, Mexico, Cuba, Santo Domingo, Haiti and the United States.

“Dual” stations in Mexico, which have interfered with broadcast reception in the United States, will be eliminated, and short-wave, police and aviation services broadened.

Police Call to Pile of Burning Leaves Heard Across Ocean

The Western Electric police radio transmitter in Mount Vernon, N. Y., with only 50 watts output, has been heard by George Garvey, an amateur, of 305 Mill Street, Liverpool. Mr. Garvey received clearly the voice transmission of Sergeant John Shields, directing police cars to a fire. Chief Inspector Michael I. Silverstein received the following request from Mr. Garvey for a “veri”:

“I have much pleasure in reporting reception of your radio station W2XNR on 36 mc, approximately, at 4.32 p.m. G.M.T. The message was ‘W2XNR MOUNT VERNON POLICE. CALLING CARS 12 AND 7. REPORT TO ALARM OF FIRE AT 105 NORTH FULTON AVENUE. THE TIME 11.32 A.M., OPERATOR 6.’ Reception was very clear and of good strength. My receiver uses only two tubes and for the antenna was using just eight feet of wire indoors. So you can see your station is putting out a swell signal over here. If you can check this report and find it correct, I certainly would be pleased to have a verification of my reception.”

The five hours difference between Eastern Standard Time and Greenwich Mean Time accounts for the two time figures.

Three policemen responded to the fire alarm which received this international attention. They discovered a pile of burning leaves.

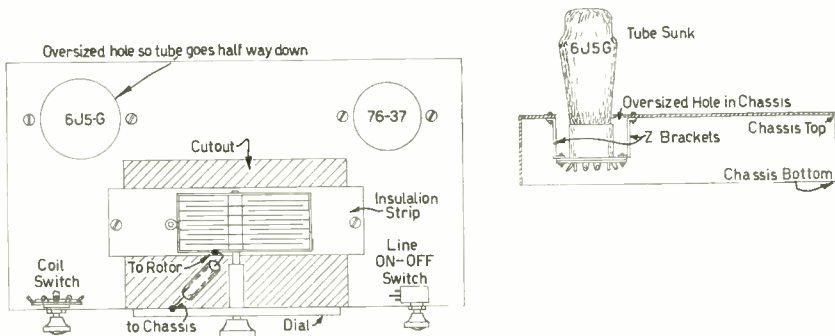
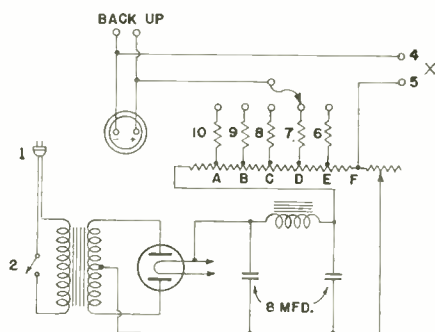

FIG. 10

Layout of the chassis is shown in top view at left, with provision for keeping tube and grid leak as far away as practical from the metal chassis. At right is a cross-section of the tube accommodation.

AN A-C OHMMETER

Included in New Triplett Instrument



The ohmmeter circuit of the new Triplett Model 1601 instrument.

THE volt-ohm-milliammeter is the one instrument that the serviceman cannot do without. It is also the one instrument that most every serviceman has and the one instrument he misuses most.

Volt-ohmmeters may be had in a variety of sensitivities and the fundamental circuits are fairly well known; however, Triplett has recently introduced a batteryless ohmmeter.

In the development of this tester several fundamental facts in resistor testing were studied. The foremost of these were that the voltage for each range of the meter must be judiciously selected to give optimum results for that range; also, the current must be well filtered and the power pack have good regulation.

CIRCUIT DESCRIBED

Servicemen are accustomed to battery type ohmmeters with their inherent defects such as, replacement of batteries, battery resistance errors, etc., and will welcome the a-c operated ohmmeter, which eliminates the battery changing and which will retain its accuracy for all time, says Triplett. Of course, battery operated volt-ohm-milliammeters will continue to be used where power supply is not available and where more portable equipment is preferred.

The following is a brief description of the circuit used in the Triplett 1601 volt-ohmmeter:

The circuit consists of a transformer connected to a full wave rectifier. The current passes through the filter and voltage divider to the negative return.

DIRECTIONS FOR OPERATION

The voltages to operate the meter are taken from the voltage divider taps. The zero adjuster consists of a variable resistor in series with the voltage divider, permitting adjustment of resistance, thus varying current so that the correct voltage drop will appear across the divider terminals.

The operation is as follows:

The cord 1 is plugged into a suitable outlet of correct frequency. Close switch No. 2, this applies a-c to the transformer primary. The output of the secondary is rectified by the 80 type tube and filtered by a 30 henry choke and two 8 mfd. filter condensers.

The current passes through the voltage divider back to transformer center tap.

Ohmmeter ranges are generally in multiple of 10. This tester has ranges of 0-2000 back-up circuit; 0-20,000, 0-200,000, 0-2,000,000, 0-20,000,000 ohms.

The voltage drop across the divider is selected and adjusted for each range.

The 0-1 milliammeter selected for ohmmeter ranges is connected to the divider, which is adjusted as follows:

For the 0-20,000 ohm range, it requires .45 volts for proper operation. With resistor C set in the center of its rotation, contact E is adjusted until there appears .45 volts across contact E and F, or 450 millivolts; therefore, some means must be provided so that the meter will not read beyond full scale when output jacks 4 and 5 are shorted.

USE AS OHMMETER

Referring to the drawing, the millivolt meter requires 100 millivolts to read full scale. The drop across resistor 6 establishes 350 millivolts. The resistor is 350 ohms. Likewise, each range of the meter is adjusted to 4.5 volts, 45 volts and 450 volts. Each resistor 7-8-9-10 is selected to give proper operation of that range. The above adjustments are factory made and need not be changed in the field.

To operate the instrument as an ohmmeter, the jacks 4 and 5 are shorted, and resistor three adjusted until meter reads full scale. The zero adjustment will not require changing for range except as the line voltage changes.

To read low ohms:

The low ohms scale consists of the familiar back up circuit in which the meter is adjusted to full scale deflection by the rheostat for that purpose.

The unknown resistor is connected across the meter terminals which acts as a shunt and reduces the reading in direct proportion to the unknown resistance, indicating the exact reading in ohms on the instrument scale.

NEW RECORD CHANGER

A new high-quality record changer is being introduced by the Garrard Sales Corporation, 17 Warren Street, New York City. This record changer will play either eight 10" or eight 12" records. There are many unusual features. It is available for any commercial type current, and also for crystal pick-up, William Carduner, in charge of sales, announced.

180-DEGREE SHADOW ANGLE

For Ray Indicator Tubes Accomplished with New Circuit

IT is possible to increase the shadow-angle sensitivity of the 6E5, 6G5, or 6U5 as a tuning indicator by increasing the maximum shadow angle from the usual value of 90 degrees to approximately 180 degrees. This improvement is obtained by using a separate triode in a new circuit to control the action of the ray-control electrode in the tuning-indicator tube. The cost of using this new circuit is only little more than the cost of the additional tube.

The circuit for obtaining wide-angle tuning is shown in the accompanying diagram. When a high negative bias is applied to T_1 , the plate current of T_1 is nearly zero and the voltage drop across R is nearly zero. Under this condition, the shadow angle is zero. When the grid of T_1 is at zero potential, the plate current of T_1 is high and the potential of point (a) is nearly -125 volts with respect to the cathode of the 6E5, 6G5, or 6U5.

CURVE WITH 76

The shadow angle under these conditions is approximately 180 degrees. In the usual circuit, the maximum shadow angle is only 90 degrees because the potential of the ray-control electrode (a) does not become negative with respect to cathode.

The accompanying curve shows the relation between shadow angle and control voltage when T_1 is a type 76. Other tube types may be used in place of the 76; the shadow-angle characteristic with the 76 is shown merely to illustrate the performance of the circuit. For example, when T_1 is a 6K5, the cut-off voltage is approximately -12 volts; when T_1 is a 6K7, the cut-off voltage is approximately -40 volts, provided the suppressor is connected to control grid and screen voltage is obtained from the 250-volt source through a 5-megohm resistor.

DEFINITION OF SHADOW

A well-defined shadow angle is not obtained over the entire range of 180 degrees. The edges of the pattern are sharp for shadow angles from 0 to approximately 150 degrees; from 150 degrees to 180 degrees, the edges of the pattern are not sharp. However, by reducing the potential of point (b) with respect to ground, the maximum shadow angle is reduced and the edges of the pattern are sharp over the entire range. A suitable compromise can be made

OPERATION OF THE 6E5, 6G5, OR 6U5

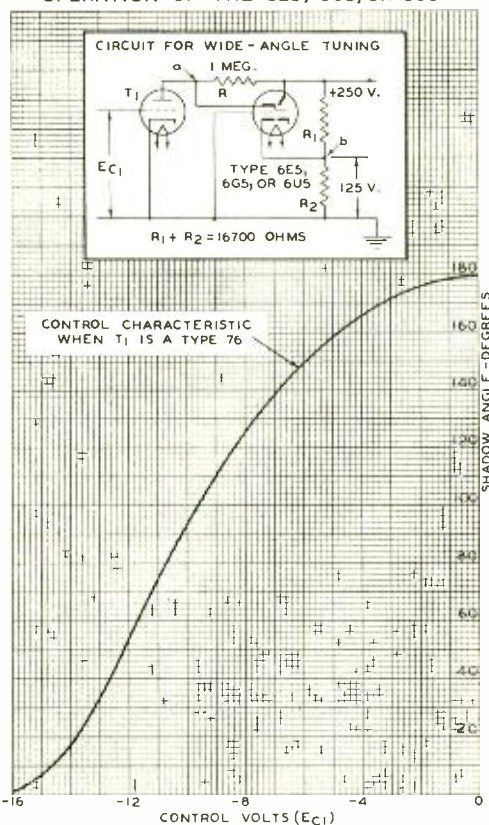

Operation of a ray indicator tube on approximately 180 degree deflection instead of 90 degrees is accomplished by the circuit shown. The curve is given also, shadow angle degrees versus control volts.

easily. In order to stabilize the potential of point (b), it is suggested that the bleeder current through R_1 be approximately 15 milliamperes.

Copyright, 1937 by RCA Manufacturing Co., Inc.

The Transmission Line on High Frequencies

By W. P. Mason

Radio Research Department, Bell Telephone Laboratories, Inc.

AS the radio art has progressed, the tendency has been to use higher and higher frequencies so as to secure a greater number of channels. The higher the frequency, how-

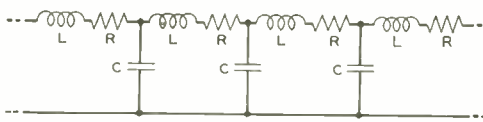

FIG. 1

Schematic representation of a transmission line.

ever, the more difficult it is to build such essential apparatus as filters and transformers because of the small values of inductances and capacitances required and the comparatively large effect of the interconnecting leads.

Also the ratio of the reactance to the resistance of the coils, or their Q value, does not increase with frequency, and as a result the percentage selectivity of the filters, which is a function of Q, can be no greater at high frequencies than at low. This means that the frequency space required to permit the loss introduced by the filter to increase from the low value over the pass band to the high value outside the band increases with frequency, and thus efficient utilization of the frequency space becomes impossible.

For use at these high frequencies it would be desirable to employ some arrangement in which the Q of the inductance elements increases with frequency.

WHEN Q INCREASES

It can be shown mathematically that a transmission line acts as an electrical network in which the resistance, inductance and capacitance are distributed in small increments along its length as shown in Fig. 1. In such a line there is nothing equivalent to the interconnecting leads since both inductance and capacitance are continuously distributed so that the connecting leads reduce to zero length. Moreover, the resistance of such a line increases as the square root of the frequency, while the inductive reactance increases directly as the frequency, with the result that the ratio of reactance to resistance, or the Q, also increases in proportion to the square root of the frequency. If sections of transmission lines could be connected together to form a filter, a number of advantages

would be secured as compared to the ordinary coil and condenser filter.

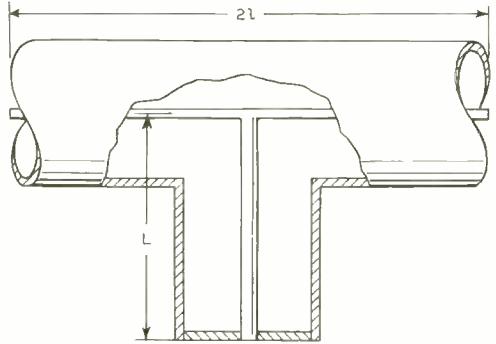

FIG. 2

A band-pass filter employing coaxial structures.

As a matter of fact, sections of transmission lines can readily be connected together to form various types of filters. A section of line, with another section connected in shunt at the mid-point, for example, gives a band-pass filter, providing the line is of such dimensions and construction that its inductance, capacitance, and resistance are of the proper values.

For use at high frequencies, a satisfactory type of line is the coaxial structure, because it is a completely shielded transmission line, and the parameters are readily changed by varying the relative diameters of the inner and outer conductors. These advantages are also shared by a shielded-pair conductor consisting of two wires surrounded by a copper shield, and such

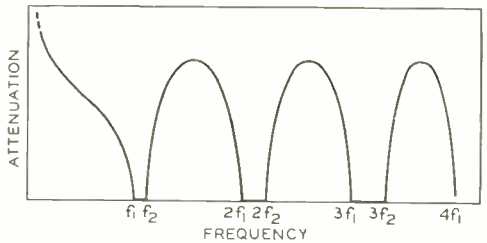

FIG. 3

Attenuation-frequency characteristic of the band-pass filter of Fig. 2.

an element is useful in balanced filter construction.

One of the simplest and most useful types of transmission line filters, using the coaxial structure, is shown in Fig. 2. It consists of a coaxial conductor of length $2l$ shunted in the middle by a short-circuited line of length L . If the line impedance of the side branch is half that of the main line, such an arrangement is a band-pass filter whose pass band lies between the frequencies f_1 and f_2 , where f_1 is the frequency necessary to make $L + l$ a quarter wavelength, and f_2 is the frequency necessary to make l a quarter wavelength. Although transmission lines can be represented by the schematic of Fig. 1, their action as filters differs somewhat from that of a conventional filter with lumped coils and condensers, since it is best represented as the transmission of waves.

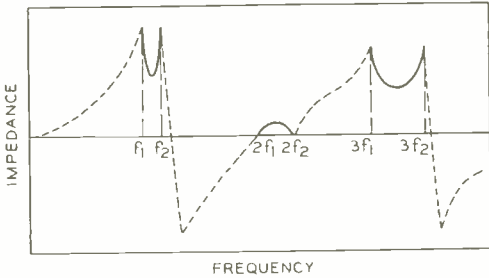

FIG. 4

Impedance characteristic of the transmission line filter.

In this respect transmission line filters are similar to acoustic filters, as pointed out in a "Bell Laboratories Record" article (August, 1928, p. 392) which showed that the transmission-line filter is the electrical analogue of the acoustic filter.

DERIVATION OF SELECTIVITY

The selectivity of a filter of this type is obtained by virtue of wave interference between the direct and reflected waves in the structure. In this respect it is similar to devices in the optical field—such as the diffraction grating—which obtain a separation of waves of different frequency by wave interference. With an input voltage impressed on such a filter as is shown

on Fig. 2, the output current will initially be that transmitted directly through the main branch, but in the meantime an electromagnetic wave will have started down the side branch. After a short period, the current reflected from the side branch will be transmitted to the output.

If the frequency of the impressed voltage is in the attenuating region of the filter, this reflected current will be out of phase with the directly transmitted current, and will result in wave interference or current cancellation, which will cause the filter to attenuate currents of this frequency. If the frequency of the impressed potential lies in the transmitting band of the filter, however, the reflected wave will be in phase with the directly transmitted wave, and the filter will transmit.

The ordinary electrical filter with lumped constants can be looked on as a limiting case of the transmission-line filter in which all the coils are equivalent to very short lengths of line of very high impedance, and condensers as open circuited lines of very short lengths and very low impedances. The output current will be the sum of all the direct and reflected waves existing in the output and hence the selectivity of a coil and condenser filter can be regarded as being due to wave interference. In fact one method of calculating the transient behavior of a coil and condenser network is to calculate the direct and reflected waves occurring, assuming the elements are short sections of lines, and then to proceed to the limit by letting the line lengths approach zero.

The attenuation-frequency characteristic of the filter of Fig. 2 will be as shown in Fig. 3. There are a number of pass bands located at harmonic intervals; the lowest pass band will be bounded by the frequencies f_1 and f_2 already referred to, and the higher pass bands will be bounded by multiples of these frequencies. The characteristic impedance of the filter will be as shown in Fig. 4. For the first band and all odd harmonic bands it will be very high, while for the even harmonic bands it will be very low.

REGULATED BAND WIDTH

Using its first band, therefore, such a filter would be suitable for connecting high-impedance tubes as shown in Fig. 5. The band width is

(Continued on next page)

FIG. 5
One use of a band-pass filter such as is shown in Fig. 4 is for connecting high impedance tubes.

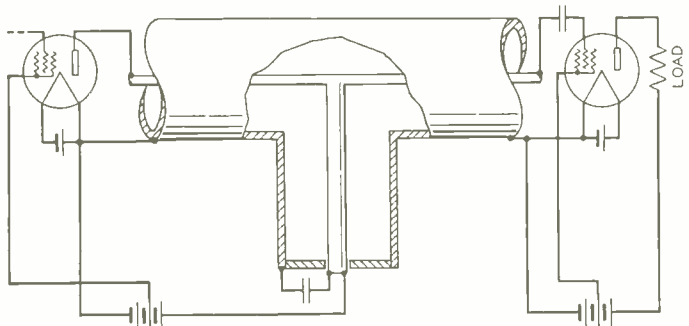

easily regulated by changing the length of the side branch, and the impedance can be varied by changing the ratio of the diameters of the outer and inner conductors.

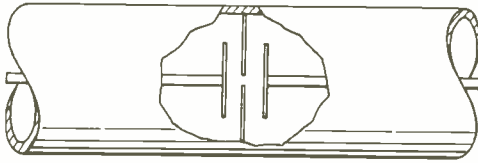

FIG. 6

A coaxial filter employing a lumped capacitance.

Since the length of such filters depends on the frequencies of the pass band, it is obvious that they would become unwieldy at low frequencies. Even at thirty megacycles, for example, the length of the main conductor would be five meters. By the use of condensers, however, shorter lengths may be employed, and this use of lumped capacitances has the further advantage of spreading apart the multiple pass bands. At high frequencies this harmonic sequence of pass bands is not particularly objectionable, since the gain of vacuum tubes falls off rapidly at high frequencies. For lower frequencies, however it is often desirable to have the secondary pass bands removed further from the main band.

Such a filter is shown in Fig. 6, where the lumped capacitance makes the branch circuit unnecessary. The attenuation frequency characteristic of such a filter will be as shown in Fig. 7. If the series capacitance is small and the shunt capacitances large, this filter will have a very narrow pass band, and will be useful in separating radio channels which do not differ much in frequency.

USE AS TRANSFORMERS

A measured characteristic for three sections of this type is shown in Fig. 8, where it may be seen that a large insertion loss is attained outside the pass band. Such a filter has been used experimentally in connection with the radio link between Green Harbor and Provincetown to permit a transmitter and receiver to be connected to the same antenna. This filter is installed at the unattended radio station, where the coaxial conductors forming the filter run vertically up one of the poles above the platform.

Besides their use as filters, these structures

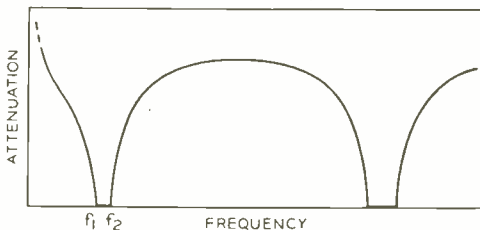

FIG. 7

Attenuation-frequency characteristic of the coaxial filter with lumped capacitance as shown in Fig. 6.

may also be made to serve as transformers by combining the transmission lines and condensers in an unsymmetrical manner. One of the simplest types of this form of transformer consists of a quarter-wavelength conductor shunted at one end by a quarter-wavelength short-circuited line of different characteristic impedance. The ratio of the image impedances at the two ends remains constant at all frequencies, so that over its pass band the structure acts as a transformer to transform from one resistance at the input to another at the output.

Such transformers have many advantages at high frequencies due to their simplicity of construction, the large amount of power they can carry, and the small loss they have in their

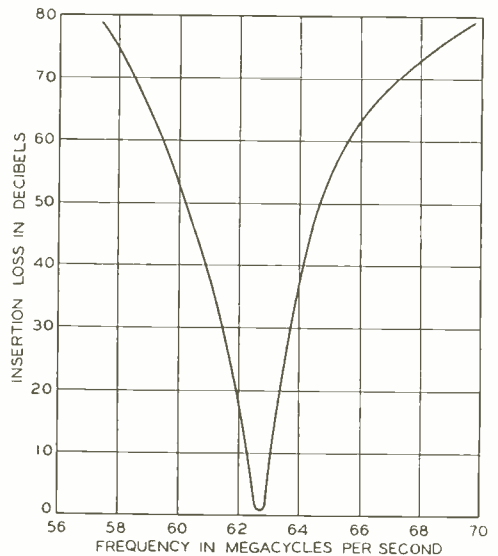

FIG. 8

Insertion loss characteristic of the lumped capacitance filter.

pass bands. By combining condensers dissymmetrically with transmission lines, a large number of types of transformers can be obtained which should be of considerable use in short-wave radio systems.

TREASURE-HUNTING CIRCUITS

By J. E. ANDERSON

Radio devices for locating buried treasure, deposits of ore bodies, etc., open a vast field for potential riches. A detailed discussion by J. E. Anderson appeared in the January, 1938, issue. Send 25¢ for a copy.

RADIO WORLD

145 West 45th St., N. Y. City.

WANTED:

A Rectifier Tube Free of Idling Current

WITHIN the past three years there has been a very marked increase in the integrity of measuring instruments used in the radio servicing industry, and it so happens that the improvement became most influential at the time when the rectifier type instrument acquired popularity. By using a sensitive d-c milliammeter and a rectifier it became possible to measure a.c. on a single volt-ohm-milliammeter, which had been a necessity long before it became a fact.

Also, multiplicity of use of meters became the vogue, so that besides a-c and d-c volts, and d-c currents and resistance there became available in the same instrument the possibility of measuring capacity and inductance.

The measurements that depended on the a-c meter were a-c volts, capacity and inductance, and any error introduced by the rectifier therefore affected all three measurements. Temperature, frailty and other factors disturbed the rectifier. Calibration, satisfactory at the time it was made, became subject to amendment by Nature.

POPULAR CONTACT RECTIFIER

The oxide-copper oxide rectifier was one type that grew to considerable importance, and naturally as troubles asserted themselves ways were adopted to correct them.

The behavior of the rectifier was reflected in the accuracy guarantee. For instance, while on d.c. the accuracy would be guaranteed as 2 per cent. of full-scale deflection, on a.c. the accuracy guarantee was 5 per cent. Assuming that the guarantee meant just what was conveyed, the accuracy on a.c. was only 40 per cent. of that on d.c.

Now, this guarantee of accuracy does not mean that the accuracy is 2 per cent. or 5 per cent. of any reading, but that at any reading the departure is not more than 2 per cent. or 5 per cent. of the departure at full-scale reading. If one takes a 10-volt range, this means that the d-c meter will not read less than 9.8 volts nor more than 10.2 volts, for 2% accuracy; and for the same range the a-c meter will read not less than 9.5 volts and not more than 10.5 volts, for 5 per cent. accuracy.

When these same voltage differences at full

scale, .2 volt in one instance and .5 volt in the other, are transferred to lower voltage readings, naturally the effective percentage accuracy becomes less, although the accuracy rating was properly given in standard manner. For example, at 1 volt a difference of .2 volt is 20 per cent. and at 1 volt a difference of .5 volt is 50 per cent. So multi-ranges for voltages and currents are frequently provided, to enable making most measurements between about three-fifth the full scale, and full scale, the lower voltage readings not to be taken below half-scale, to avoid too great an error.

CONTACT RECTIFIERS IMPROVED

There are certain difficulties attendant on the manufacture of a meter that, at the low prices servicemen enjoy, prohibit devoting enough pains and money to the production of a meter more accurate than 2 per cent. of full-scale, but when decadent rectifiers are serious offenders the inclusion of multi-voltage scales, and multi-current scales, to improve accuracy, does not agree with the inclusion of rectifiers in which the accuracy is not of great duration. Then, in fact, the accuracy guarantee for a.c. becomes a function of time, temperature and shock.

Now the better grade instrument makers are marketing oxide-copper oxide rectifier types with smaller temperature error, and with otherwise improved performance, whereby the accuracy guarantee is increased to 3 per cent. The a-c meter can not equal the accuracy of the d-c meter unless there is no additional error introduced by the rectifier.

IDLING CURRENT

However, the vacuum tube has been the very heart of radio's existence and growth and there is no reason why it should not find its welcome place in measuring instruments for servicemen, without requiring considerable extra equipment and cost. Fundamentally the vacuum tube is attractive because it is not nearly so frequency-discriminating as the other types of rectifiers, so instead of just encompassing the audio spectrum with small departure from calibration, it could encompass up to one megacycle or more, in

(Continued on next page)

(Continued from preceding page)

service instruments, and though drawing a small current (say, half a milliamperere or less), could be adapted to vacuum-tube voltmeter measurements, at the second detector, with a proportionality circuit for reducing shunting effect.

However, one difficulty is the idling current through the rectifier.

Due to the heat from the heater establishing thermal coupling to the cathode, the moment the external circuit is closed, particularly by a good conductor, these undeterred electrons are carried by their initial velocity, and we may have a substantial reading at no external input.

Since the initial velocity effect is equivalent to the presence of a fixed series voltage, naturally the higher the load resistance the smaller the current that flows at no external input. Since the external input is the voltage to be measured, the meter should read zero when there is no external input, but it does not read zero, far from it, unless the load resistance is high compared to the resistance of the rectifier tube. This would mean around 50,000 ohms minimum, or, for a 0-1 milliammeter in a rectifier type meter, say, 50 peak volts full scale, or 70 volts r.m.s. Nobody wants an a-c voltmeter for service work with such a high magnitude of "low" voltage range.

Current present without doing any useful work may be properly called idling current, and when present due to one cause can be balanced out by some additional means. Therefore we may introduce a bucking circuit. Often there would be a separate and distinct bucking current value for each low range, until the range becomes high enough so that the multiplier resistance limits the current flowing at no external input to make it appear that the needle points to zero.

WIDER APPLICATION

That is all right, to use false zero as real zero, where the difference is so small you can not notice it, as you are then well within the reading limitation of the instrument. But most circuits for proper bucking require an extra rectifier or cell, and resistors not only have to be separate, but may have to be independently adjustable. Nobody wants to make a separate zero adjustment every time he switches to another range.

Any designs for rectifier type instruments using vacuum tubes must take this idling current into account, and no circuit is useful for low ranges of a.c. volts unless this problem is satisfactorily solved.

A contact rectifier, having no heater with associated cathode, is free of this effect, and so the tube manufacturers have a problem to solve that is worthy of their attention, to produce a rectifier type tube for instruments at a reasonable price, and possessing practically no idling current.

NO EASY TASK

Much wider application of the benefits of idling current elimination is possible, e.g., as a

KIND WORDS

I have been buying RADIO WORLD for three years. On receipt of each month's copy I read it through from front to back and then read over the articles a second time before I put the book away for reference.

J. A. STERLING,
Sterling Radio Service, Parksville,
B.C., Canada.

* * *

RADIO WORLD is the meatiest magazine on the newsstands today! I am a builder, experimenter and part-time service-man and RADIO WORLD sure hits the spot for me. I ESPECIALLY APPRECIATE THE FACT THAT I CAN READ ANY ARTICLE IN THE MAGAZINE WITHOUT HAVING TO TURN TO THE BACK OF THE BOOK TO FINISH IT, AND THEN TURNING TO THE FRONT AGAIN TO READ THE NEXT ARTICLE, etc.

WALTER FLETCHER,
Wyaconda, Missouri.

* * *

Let me register my deepest appreciation of your unique radio journal of which I am a regular reader.

WM. J. CLARKE,
Radio Service Man, 1234 High St.,
Malvern, S.E. 4, Victoria, Australia.

means of hum reduction in amplifiers, so the suggestion is not of restricted value.

All types of rectifiers for instrument use may have their worth diminished because they have too high a resistance when conducting. It has been pointed out that the absence of the heater is favorable to the contact type rectifier, but the vacuum tube can have the edge when it comes to conductivity, or low resistance.

With a special tube, admittedly no easy task, the required limiting resistance for a sensitive d-c milliammeter could be large for a low range while the current through the tube alone could be one grand rush.

The high resistance present in the contact rectifier, and which also limits the low voltage range to a certain maximum, for a certain sensitivity d-c meter, need not be present in the vacuum-tube rectifier, and while it is of course possible that contact rectifiers could be developed with very low resistance, already tubes exist that have much smaller resistance than contact rectifiers.

The tube manufacturers should be interested in the subject from a viewpoint other than that of the limited sale of tubes to instrument makers and servicemen, compared to the sale that the general public enables, because the instruments are used in servicing the very receivers that enable the large sale of tubes. And besides there is wide non-servicing application for such tubes.

NOT WANTED:

Door Prizes At Service Meetings

SERVICE organizations at their branches throughout the country are addressed by technical salesmen, and to induce a large attendance door prizes are offered. These usually consist of servicing instruments obtained, if possible, without cost, and if not possible that way, then there are no door prizes. Since no admission is charged, there is no fund with which to finance these lures.

Thus the serviceman has his modest Bank Night and a gambler's usual tiny chance of winning anything.

The talks are at somebody's expense, so naturally enough the listeners hear a great deal about the necessity of buying a particular new instrument, otherwise face the imminent peril of being forced out of business. It seems you can not prosper or even survive unless you follow the technical salesman's advice, and you had better trade in your old testing equipment to a jobber who won't take it, and get the new device.

CONSISTENT TECHNIQUE

The technique has been consistently that, to such an offensive extreme that a new tack is being tried by some, for the folly of trying to cram new instruments on servicemen under implied or open threat has finally been made apparent to the most blatant offenders.

Certainly the improvement in instrumentation has been so great and the needs of new measurements are so apparent that servicemen will want new apparatus, and as fast as their means allow, they will buy it. Probably they know better than the instrument maker how much their success depends on the quality and appropriateness of their instruments. It must therefore be tiresome to hear the same sales prattle time and again, and to have the supposedly instructive technical talk turn into a high-pressure sales talk. There is much worth in new instruments, and in information about their use and application, but the value is greater, the less the ballyhoo.

The object always nearest to the speaker's heart is that omnipresent new instrument, while there are questions of great variety and scope that are bothering the servicemen, and that he

would prefer to hear answered, than to listen to a diatribe on the new product. The speaker is entitled to his "credit," or discussion of the real motive that actuates him to address the gathering, for he is as free of altruism as any prodger, but he should find out first what is uppermost in the minds of servicemen, and talk to them on those subjects. Incidentally he can mention the instrument.

SHOW DOESN'T PULL

Slim attendance therefore can be assumed the real reason, besides a sort of habit, why door prizes prevail. Slim attendance, however, is better cured by having speakers who are personally and topically more interesting, because the door prize is some evidence that most speakers at these meetings are bores. A door prize will conceal many a yawn, if there are enough door prizes.

However, if the boring of listeners is more successful, there may be more door prizes than servicemen at the meeting, so that "there will be no blanks" in this merry gamble, and some servicemen attending session will get two prizes. If they forget completely what the speaker said, that will not matter much because the final purpose of the meeting becomes a distribution of prizes, and servicemen will be able to amass a valuable stock, and turn into prosperous jobbers, without having to spend a cent. Then instrument makers can reduce expenses in the bookkeeping department, as there will be no need of handling accounts receivable, because, it will be remembered, free instruments are given.

THE FINAL OUTCOME

With every serviceman his own jobber, there will be no other jobbers, and as door prizes will take care of every serviceman's needs, he will not have any customers for the stock for which he paid nothing, and so, alas, although for another reason, the fearful threat of being driven out of business will come true. Meanwhile the instrument makers will go into the rendering business and live on the fat of the land.

The sooner the servicing industry gets rid of its Bank Night the better.

Constants for Quality A.F.

In Resistance-Coupled Amplifiers, Using 150 Milliampere Heater Tubes

THIS Note furnishes detailed information on the operation of the 6L5-G and 6S7-G as resistance-coupled audio-frequency amplifiers. These tube types are, respectively, a general purpose low- μ triode, a duplex-diode high- μ triode and a super-control pentode. Because the heater current of these types is only 150 milliamperes at 6.3 volts, they are primarily intended for use in applications requiring low heater power. The resistance-coupled amplifier data are presented in tabular form for easy reference.

The use of series resistors in screen and cathode circuits offers several advantages over fixed-voltage operation: (1) the effects of possible tube differences are minimized; (2) operation over a wide range of plate-supply voltages without appreciable change in gain is feasible; and (3) the low frequency at which the amplifier cuts off can be easily changed. Fixed-bias or fixed-screen-voltage operation increases the tendency of an amplifier to motorboat and decreases the compensating action of the remaining series resistors.

OTHER CUTOFFS OBTAINABLE

For the triode types 6L5-G and 6T7-G, the values of coupling condenser (C) and cathode-resistor by-pass condenser (C_c) were chosen for an output voltage at 100 cycles of 0.8 the value at 420 cycles. A similar cut-off characteristic at any other low frequency (f_1) can be obtained by multiplying the capacitance values shown by $100/f_1$.

On the chart, the values of C_c are given for an amplifier with d-c heater excitation. When a-c is used, depending on the character of the associated circuits, the gain, and the value of f_1 , it may be necessary to increase the value of C_c to minimize hum disturbance.

In the case of the pentode type 6S7-G, the values C, C_c and C_a were chosen for an output voltage at 100 cycles of 0.7 the value at 420 cycles. A similar cut-off characteristic at any other low frequency (f_1) can be obtained by multiplying the capacitance values shown by $100/f_1$. The comments in the previous paragraph regarding hum disturbances apply for the 6S7-G as well as for the triode types.

NEGLECTIBLE GRID CURRENT

The output voltages listed in the chart obtain for operation at the grid current point; negligible grid current flows at these output voltages. Distortion at maximum output is approximately 5 per cent in all cases.

The data are presented for plate-supply voltages of 90, 180, and 300 volts. When self-bias and series-screen operation are used, the plate

voltage may vary approximately 50 per cent with small change in gain. Output voltage, of
(Continued on next page)

Notes on Triode Circuit

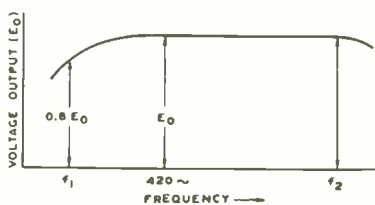

Frequency characteristic of single-stage, resistance-coupled triode amplifier.

A. Condensers C and C_c have been chosen to give output voltages equal to $0.8 E_o$ for f_1 of 100 cycles. For any other value of f_1 , multiply values of C and C_c by $100/f_1$.

In the case of condenser C_c , the values shown are for an amplifier with d-c heater excitation. When a-c is used, depending on the character of the associated circuits, the gain, and the value of f_1 , it may be necessary to increase the value of C_c to minimize hum disturbances. It may also be desirable to have a d-c potential difference of approximately 10 volts between heater and cathode.

B. f_2 = frequency at which high-frequency response begins to fall off.

C. The voltage output at f_1 for n like stages equals $(0.8 E_o)^n$.

D. Decoupling filters are not necessary for two stages or less.

E. For an amplifier of typical construction, the value of f_2 is well above the audio-frequency range for any value of R_{L_2} .

F. Always use highest permissible value of R_g .

G. A variation of $\pm 10\%$ in values of resistors and condensers has only a slight effect on performance.

[See diagram at left, bottom of page 27]

RESISTANCE-COUPLED AMPLIFIER CHART

C = BUCKING CONDENSER (μF) E₀ = VOLTAGE OUTPUT (IPASS VOLTS) R_L = PLATE RESISTOR (megohms)
 C_c = CATHODE BY-PASS CONDENSER (μF) E_{bb} = PLATE-SUPPLY VOLTAGE (VOLTS) V.G. = VOLTAGE GAIN

R_g = SCREEN RESISTOR (megohms) R_e = CATHODE RESISTOR (OHMS)

R_g = SCREEN OUTPUT (IPASS VOLTS) R_e = CATHODE RESISTOR (OHMS)

TRIODE TYPE 6L5-G

Ebb 1		90		180		300		Ebb 1	
RL	RL	0.1	0.25	0.5	1.0	0.25	0.5	1.0	2.5
Rg	3.1	3.25	3.5	3.75	4.0	4.25	4.5	4.75	5.0
Rc	21.80	2900	3510	4620	5200	8050	10300	12100	1810
Cc	2.3	1.85	1.65	1.36	1.09	1.1	1.1	1.1	1.1
C	3.05	0.33	0.14	0.035	0.015	0.0085	0.0045	0.0025	0.0015
E ₀	14	17.3	21	26	31.5	37.5	43.5	50	64
V.G.	9.3	10.4	12.9	16	21.5	25.6	32	41	52.9

DUPLEX-DIODE HIGH-MU TRIODE TYPE 6T7-G

Ebb 1		75		180		300		Ebb 1	
RL	RL	0.1	0.25	0.5	1.0	0.25	0.5	1.0	2.5
Rg	0.1	0.25	0.5	1.0	1.5	2.0	2.5	3.0	3.5
Rc	4390	4790	5190	5590	6000	6400	6800	7200	7600
Cc	1.8	1.5	1.43	1.12	0.99	0.87	0.76	0.66	0.56
C	0.23	0.12	0.07	0.035	0.02	0.012	0.0075	0.0045	0.0025
E ₀	5.6	7.8	8.5	10.2	11.5	12.8	14.2	15.6	17.0
V.G.	20.3	24	25	28.2	30	31.5	32.9	34.2	35.6

PENTODE TYPE 6S7-G

Ebb 1		75		180		300		Ebb 1	
RL	RL	0.1	0.25	0.5	1.0	0.25	0.5	1.0	2.5
Rg	0.1	0.25	0.5	1.0	1.5	2.0	2.5	3.0	3.5
Rc	810	930	1100	1240	1400	1520	1600	1700	1800
Cc	0.005	0.0025	0.0015	0.00075	0.00045	0.00025	0.00015	0.000075	0.000045
E ₀	16	20.5	22.5	25	27	28.5	30	31.5	33
V.G.	33.3	40.2	43.5	46.5	48	49.5	51	52.5	54

1. Voltage at plate equals Plate-Supply voltage minus voltage drops in R_L and R_c. For other supply voltages, correct values of voltage output, however, for any of these other supply voltages equals the listed voltage output multiplied by the new plate-supply voltage divided by the plate-supply voltage corresponding to the listed voltage output.
 2. For following stage (see Circuit Diagram).

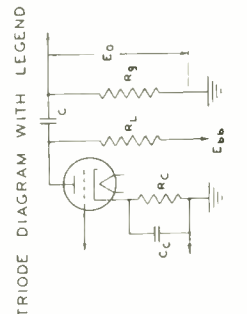
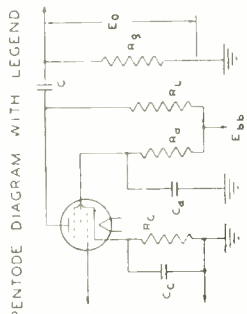

Notes on Pentode Circuit

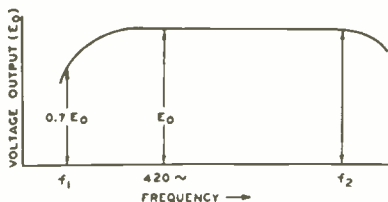

Frequency characteristic of single-stage, resistance-coupled triode amplifier.

A. Condensers C, Cc, and Cd have been chosen to give output voltages equal to $0.7 E_o$ for f_1 of 100 cycles. For any other value of f_1 , multiply values of C, Cc, and Cd by $100/f_1$.

In the case of condenser Cc, the values shown are for an amplifier with d-c heater excitation. When a-c is used, depending on the character of the associated circuits, the gain, and the value of f_1 , it may be necessary to increase the value of Cc to minimize hum disturbances. It may also be desirable to have a d-c potential difference of approximately 10 volts between heater and cathode.

B. f_2 = frequency at which high-frequency response begins to fall off.

C. The voltage output at f_1 for n like stages equals $(0.7 E_o)^n$.

D. Decoupling filters are not necessary for two stages or less.

E. For an amplifier of typical construction, approximate values of f_2 for different values of R_L are:

R_L	f_2
0.1 Meg.	20000 cps.
0.25 "	10000 "
0.5 "	5000 "

F. Always use highest permissible value of R_g .

G. A variation of $\pm 10\%$ in values of resistors and condensers has only slight effect on performance.

[See diagram at right, bottom of page 27]

(Continued from preceding page)

course, varies with plate-supply voltage. The extent to which the output voltage is affected by variation in plate-supply voltage can be roughly approximated by assuming that the relation between output voltage and plate-supply voltage is linear.

Copyright, 1937, by RCA Manufacturing Co., Inc.

NEW SLIDE RULE FOR RADIO FINDS DECIMAL POINT

National Union Radio Corporation is making available a new radio slide rule for radio engineers, designed by W. M. Perkins, of the National Union Commercial Engineering Department.

Mr. Perkins developed the new rule for use in connection with radio engineering work being carried on under his supervision. After using it and proving its worth as a time saver, it was decided that the rule would be of exceptional value to members of the radio engineering profession generally.

A ONE-SETTING METHOD

The purposes of the rule according to Mr. Perkins are to permit the rapid determination of (1) capacitive reactance when capacity and frequency are known, (2) inductive reactance when inductance and frequency are known, and (3) resonant frequency when capacity and inductance are known.

As a corollary in each of these three cases, the determination of the unknown quantity, when any two of the three quantities are known, may be readily accomplished.

Mr. Perkins states that conventional slide rule solutions of these problems have in general two drawbacks: namely, the necessity for several settings to find the answer, and no provision for determining the decimal place in the final answer. The National Union Radio Slide Rule has been designed to overcome these limitations, providing as it does the answer to problems with only one setting of the slide and the position of the decimal place automatically indicated.

ACCURACY DISCUSSED

The range of scales has been chosen so as to include the major portion of values in which the average radio engineer is interested. The ranges are:

- Scale 1: Capacity—100 mmfd. to 100 mfd.
- Scale 2: Inductance—1 ohm to 1 hy.
- Scale 3: Frequency—16 cycles to 16 megacycles.
- Scale 4: Reactance—100 ohms to 100 megohms.
- Scale 5: Resonant Frequency, 16 cycles to 16 kc.
- Scale 6: Resonant Frequency, 16 kc to 16 megacycles.

Four of the scales appear on the front of the rule properly identified by numbers at the left, while scales 5 and 6 are on the reverse side of the slide.

The rule is made by Keuffel & Esser.

RIGHT OR WRONG?

Propositions

- 1 Direct current travels two ways. In a vacuum-tube circuit it travels from positive to negative, and in most other circuits it travels from negative to positive.
- 2 The quantity of capacity needed for reducing the hum to a certain low level is less for a full-wave rectifier than for a half-wave rectifier, because the capacity is twice as effective, generally speaking.
- 3 When a meter is put in series with the diode second detector of a superheterodyne, then a station tuned in, the pulsating direct-current flowing is the same whether there is modulation or not, so long as the carrier itself remains the same.
- 4 When an oscillator is stabilized for one purpose it is stabilized for all purposes, hence line voltage change will not alter the frequency of oscillation any more than will change of applied plate voltage or even filament voltage, percentages being considered.
- 5 A galvanometer is an instrument that has zero center reading and calibrated currents or volts increasing to left and to right, so that whether current or voltage ascends or descends from zero, there is always a reading without necessity of reversing the meter.
- 6 The electromotive force of a dry cell is exactly 1.5 volts and may be relied on as a standard of accuracy for d.c. within the requirements of service practice.

Answers

- 1 Wrong. Direct current flows in one direction only, i.e., from negative to positive. In early days the opposite was believed. Meters and formulas were based on the positive-to-negative assumption. Hence positive-to-negative direction is acceptable as conventional. To get around the earlier mistake it is said, without truth, however, that the "current flows from positive to negative but the electrons from negative to positive." Positive and negative apply to the external circuit. Although the direction is no different, the signs are changed in the generator or supply circuit.
- 2 Right. The capacity reactance is inversely proportionate to frequency, therefore since the full-wave rectifier doubles the frequency the reactance is halved, and the capacity may be roughly described as being "twice as effective" for that reason, although the total effect on hum reduction also includes inductance and resistance.
- 3 Right. The diode type rectifier as ordinarily used, composed of tube with resistor in series both with the a.c. and d.c. circuits, and bypass condenser across the resistor to remove the carrier from the resistor, responds to the *average* of the carrier amplitude. Whether the carrier is modulated or not, the average amplitude of the carrier alone is the same, because the carrier itself is not made more or less by modulation, but only the sidebands.
- 4 Right. Stabilization means that the oscillator will maintain its constancy of output regardless of small changes of terminal voltages. Therefore if the oscillator is stable it generates a frequency that stays put at an amplitude that stays put, and confirmation of the stability of one is confirmation of the stability of both.
- 5 Wrong. A galvanometer is an uncalibrated current-indicating meter, though it may have scale in relative terms, or no scale at all, and whether the zero is set at center, as it usually is, or at left, makes no difference in the character of the instrument.
- 6 Wrong. The electromotive force of a dry cell is somewhat in excess of 1.5 volts, and may be taken, for a good enough approximation in service work, and for use as a sort of standard, as 1.55 volts. Thus for a 22.5-volt B battery, which has 15 cells, the e.m.f. would be 23.25 volts, and for a 45-volt B battery 46.5 volts. It will be noticed that fresh batteries, measured with a sensitive voltmeter (5,000 ohms per volt or better) usually read these higher values. The actual voltage read depends on the current drawn and the resistance of the batteries, or cells, which increases with age and use.

very serious, as the same cause that produced the rising characteristic of sensitivity also produced a rising characteristic of selectivity, i.e., regeneration.

It is the regenerative action that contributes both increase of selectivity and of sensitivity, and it may be said then that the coils could be used to produce uniform action, adding where there is too little and subtracting where there is too much. The coils themselves, any type, will tend to diminish the selectivity as the frequency is increased, and likely as not the gain as well, as the losses accumulate with increase of frequency, if one ignores regeneration.

With the r-f channels there is little or no trouble, but when one comes to the detector stage a choice must be made. On the score of sensitivity, with quality consistent with that of which the power output circuit is capable, a biased pentode will serve, as in the diagram.

DIODES OF TWO TYPES

This treatment is more selective, though less sensitive, than the grid-leak-detector method. Since no load is put on the tuning system, and fairly good audio quality is obtainable, it may be desirable to increase the gain, even at the expense of quality detection, and this could be done readily, in the circuit as shown, by reducing the detector screen resistor, shown as 2 meg., to .1 meg., or omitting it entirely, although the tube, less sensitive of course, is a better quality detector when the illustrated method prevails.

Diodes do not usually find favor in t-r-f sets because the diode return circuit is to a resistor load that becomes associated with the tuning system, and elevates the rotor above ground potential. That is, if the usual method is followed. If a three-gang condenser is used, naturally the common frame can be at only a single potential, hence a filter circuit is sometimes used to enable this, although it reduces selectivity and, moreover, unless specially matched, upsets the tracking, because a choke coil is effectively in parallel with the tuning coil secondary, reduces the inductance of that secondary, and a trimmer condenser adjustment cannot properly compensate for this, except at a single frequency. And yet we want to cover perhaps a hundred channels or frequencies.

The so-called infinite impedance diode offers possibilities, however.

CRITICAL RESISTORS

This consists of a triode so hooked up that 250 volts are applied directly to the plate, while the cathode leg has a load resistor, and grid is returned to the end of this resistor, with audio taken from cathode through a .1 mfd. stopping condenser, and feeding a grid leak in the audio stage. That is, a driver, or audio amplifier tube, ahead of the power tube is advisable, unless a fairly high mu phase inverter, as the 6C8G, is used. A single-sided power tube output could be most simply utilized. There is an element of criticality in regard to the cathode resistor and the grid leak, a certain ratio being required, but if the cathode load is made 50,000 ohms, the grid leak may be made 80,000 ohms, and

a mica condenser of .00025 mfd. or thereabouts may be put across the cathode resistor.

This circuit will produce a little more hum than the usual run of detectors, due in part, no doubt, to its excellent low-frequency response, although other causes intervene to augment the result. So the filtration must be better than in the run of sets, and is accomplished mainly in the B supply. A series detector plate resistor of .05 meg. to .1 meg. may be used, with 8 mfd. from plate to cathode, but then the two resistors already mentioned had better be 180,000 and 300,000 ohms, respectively. The stopping condenser remains the same.

APPLICABLE TO PUSH-PULL

The circuit diagram herewith calls for push-pull output, and the infinite impedance diode—so-called because it has the characteristics of a diode, as to linearity, and does not draw any current from the radio-frequency line—is applicable also to push-pull. Those interested in such a phase of the special detector are referred to another article in this issue on the push-pull subject.

The tuning condenser frame trouble is absent, when the infinite impedance diode is used, because the secondary is returned to ground, in the inductance feeding the detector. Moreover, the load is a pure capacity reactance, and thus requires only a trimmer adjustment for compensation. Also, that compensation is as good all over the band as if any other type of detector were used. It is not pretended that t-r-f sections, coils and condensers considered, track perfectly all over the band. It is known they do not.

Congressional Inquiry Asked into Radio "Trust"

Washington

Attacking an appropriation of \$1,745,000 on the Federal Communications Bill, Representative Wigglesworth, of Massachusetts, said that radio, though under Federal control, is a "dangerous" monopoly. In asking for a Congressional investigation of this "monopoly" he said:

"Here is a monopoly of the most dangerous kind, under the complete control of the national government, which may fairly be said to have been directly sponsored by that government."

MALCOLM FERRIS DIES

Boonton, N. J.

Malcolm Ferris, designer and manufacturer of the Ferris signal generator used by set manufacturers, died here recently, age 43. He was born in Glenside, Pa., was graduated from Haverford College and was a pioneer in amateur radio. He had been employed by the United States Navy and Radio Frequency Laboratories.

APPROXIMATION

Rules in Nearly All Tube Testers

By M. N. Beitman

Wholesale Radio Service Company

THE determination of a particular tube's ability to perform the required function is of prime importance to radio servicemen and experimenters. The modern commercial tube testers test satisfactorily only the emission properties and possible shorts between a limited number of the tube's elements. While this test procedure is the only practical non-laboratory test, the men engaged in radio construction and repair must realize and understand the shortcomings of such tests.

Although a diode (two-element) vacuum tube was the firstcomer to radio and is used even today, the development of modern radio transmission and reception is due mainly to the use of the three-element tube. The triode included a grid consisting of a mesh of fine wires placed geometrically in the field between the cathode and the plate. The location of the grid much nearer to the emitting cathode than the plate permits the control of relatively large plate currents with small grid voltages.

NEGATIVE GRID FOR CLASS A

In Class A circuits the grid is kept at sufficiently negative potential at all times to prevent any grid current flowing and, because of this, very little signal power is needed to operate the vacuum tube. Under such conditions tubes are used as voltage amplifiers for all employed frequencies and may also serve as high quality—but not very efficient—output tubes.

In Class B operation the tube is biased or designed with a sufficiently high amplification factor to cut off the plate current at no input signal. When a signal sufficient to swing the grid is introduced, the negative portion of the cycle will add to the bias and therefore no plate current will flow then, either, but the plate current will flow, during the positive half of the cycle it will flow. Since at times the grids are driven positive, some grid current will flow.

In Class C r-f amplifiers the tubes are biased at twice the cut off bias, and high grid currents occur only during a very short duration of the positive alternation.

The properties of triodes are related directly to the operation of other multi-element tubes and must be further analyzed for a better understanding of test requirements.

The amplification property of a vacuum tube is due to the nature of the construction which enables a small grid potential change to have the same effect upon the plate current as a much larger plate potential change.

THE AMPLIFICATION FACTOR

The ratio of the small change in the plate voltage E_p to the small change in the grid voltage E_g that will hold the plate current constant is called the amplification factor, or the Greek letter μ . Expressed mathematically this is:

$$\mu = \frac{dE_p}{dE_g}$$

where d means the differential, a very small change.

The plate resistance (r) of a tube is the resistance to alternating current of the path between the plate and cathode. It is the ratio of a small change in the plate voltage to the corresponding change in the plate current. That is:

$$r = \frac{dE_p}{dI_p}$$

Mutual conductance (transconductance or G_m) combines into a single factor the amplification factor and the plate resistance. Mutual conductance is the ratio of a very small change in the plate current I_p to a very small change in the grid voltage E_g , with the plate voltage remaining fixed.

$$G_m = \frac{dI_p}{dE_g}$$

Mutual conductance is also equal to the amplification factor divided by the plate resistance.

The detrimental effect of inter-electrode capacity existing between the grid and plate may be removed by the introduction of a fourth electrode, the screen grid in the tetrode. But the screen attracts the electrons dislodged from the plate by secondary emission and thereby lowers the effective plate current.

EFFECT OF SUPPRESSOR

This limitation may be removed by a further introduction of another electrode, commonly

known as the suppressor, between the screen and the plate. The suppressor may have an external prong connection or may be connected directly to the cathode or filament. Since such tubes have five elements, they are called pentodes.

The characteristics of vacuum tubes are presented by means of curves. The plate current, plate voltage, and grid voltage are taken as the three inter related factors. Each curve represents a condition with one of the factors remaining constant. In making up curves for pentodes additional factors must be considered and certain primary conditions must be set to permit only two factors to vary. A simple method has been developed for converting pentode characteristics for conditions existing between any two known conditions.

Vacuum tubes are not only used for voltage amplification and power output, but also for oscillation and detection. Many of the multi-element tubes perform a number of distinct functions or combine the equivalent of two separate tubes in a single glass envelope. These facts are important to keep in mind when considering later the ability of the emission tester accurately to test these various tubes. You will understand later that a simple emission type tester can test satisfactorily only rectifier tubes and serve only as a rough check for other types.

INSULATION OF ELEMENTS

For proper operation of the tube the various elements of the tube must be insulated from each other. Common faults that develop in tubes are shorts between elements and particularly between the cathode and the filament in the indirectly heated tubes. An efficient short test would test for all possible shorts between the various elements. For example, in the case of five elements, four elements are connected together and tested for existing short to the remaining element. Next a different single element is selected and tested for shorts to the remaining elements. In this manner for a five-element tube five distinct tests are made.

The majority of commercial tube testers, however is not designed for such exacting tests. In many types of tube testers the only short test used is between the cathode and the filament. In other units individual elements are tested for existing shorts to the cathode only. You can readily see shortcomings of these tests, but the method is general because simple, rapid, inexpensive and on the average useful. A store owner or a radio serviceman could hardly afford to spend half an hour on every tube tested and must resort to a practical, quick test that will detect the majority of faults.

EMISSION TEST SIMPLEST

Since all the tubes of any one certain type have the identical characteristics, ordinarily the comparative quality of any single characteristic is sufficient to determine the serviceability of a tube. The emission test is the simplest and, while it does not directly indicate the actual dynamic characteristics of the tube, the correlation that exists between the emission and the

other factors permits a rough judgment of the tube's condition. In practice this test proved commercially successful with a large number of tube testing equipment manufacturers using this system. The occasional tube that is really bad, but which has the total emission up to par because of an active cathode spot, brings home the limitations of this test.

Just what is an emission tester? The tube tester of this type ordinarily has a filament voltage selector which must be set to apply the correct voltage to the filament of the tube under test. Sockets are provided for tubes of the commonly employed bases; this includes the four, five, six, combined seven large and small, and octal sockets. A four- or five-point selector or perhaps a collection of toggle switches connect the cathode to the negative side of a high-voltage supply, while permitting all other elements (except the filament) to be tied to the plate for the positive potential.

GOOD—?—BAD TESTS

The tube is now the equivalent of a diode. A potentiometer knob or selector switch adjusts the plate voltage for each specific type of tube, or a single voltage, usually 30 volts, is made to suffice. In this manner all tubes having enough emission will pass a current of a value to deflect the meter needle into the Good portion of a scale reading Good—?—Bad. This scale is coincided with different tubes by consulting a chart. A tube with poor emission will pass insufficient current and the needle will remain in the Bad section.

Each manufacturer, of course, adds his own modifications to his make of instrument. There is a unit on the market, for example, that must have its indicating needle adjusted to a center point by the operator. This adjustment in turn places in the 110-volt circuit one of three electric lights that are placed under glass covers marked, Good, Weak and Bad respectively.

The power output test is well suited to determine the actual serviceability of a vacuum tube.

MUTUAL CONDUCTANCE

A good test to determine the quality and performance of a vacuum tube is the mutual conductance test. This test permits true judgment between test results and performance. While a number of different tests may be used to determine the mutual conductance of a tube, the simplest and the most commonly used method applies fixed potentials to the elements of the tube and shifts the grid voltage a slight amount. The change in the plate current due to this grid voltage shift may be resolved into a measurement of mutual conductance. This test is too difficult for commercial application because each tube element of every different tube will require a different value of potential.

The tube checker should be judged as a rough indicator of the tube's probable performance. It should further check for possible shorts between elements. Except for the very occasional tube the commercial units carry out these requirements.

Economical Push-Pull Phase Inverter Fully

By Walter

ECONOMICAL operation of a push-pull audio circuit may be attained by using the 6B8G as signal detector and automatic volume control supply, feeding the audio to a 6C8G phase inverter, and working push-pull output tubes that require no more than 20 volts negative bias. It is possible to load up the output tubes, since an output signal from the detector of only .4 volt r.m.s. is required, distortion total being well under one per cent.

The diode section of the 6B8G, as shown in the diagram, is fed by the secondary of the second i-f transformer, upper right, which in turn received its feed from the amplifier section of the 6B8G.

The system is well adapted to use in home receivers, especially for such uses as require minimum of hum, because the infinite impedance diode, although having superior modulation capabilities, does produce more hum, requires a much better B supply filter, and even then is not as hum-free as some would desire.

SOME HUM DIFFICULTIES

The reasons for this are not universally recognized but mainly must be associated with the idling current, since the heater warms up the cathode, and the cathode is "connected" in the plate circuit by thermal coupling, or flow of initial velocity electrons, which carry a hum component.

For those who care to work out their own solutions of hum difficulties, the infinite impedance detector with push-pull could be used, but meanwhile a brief discussion will be given of the regular diode detector with inversion for push-pull.

While the circuit has a few unusual features, it follows the familiar general principles: (1) The diode is fed by i-f voltage, and has a load resistor, or network; (2) the audio voltage developed for amplification purposes is fed into one section of a dual triode, the output of which is much greater than the input; (3) this output, for feeding to the input of the other triode, has to be reduced in the same proportion as the amplification or increase provided by the first triode; (4) the equalized voltages, being in opposite phase, are fed to the grids of the push-pull tubes.

These facts we see confirmed in the first diagram. The diode circuit is returned to cathode through .25 meg., and while from the same point a 1 meg. potentiometer goes to

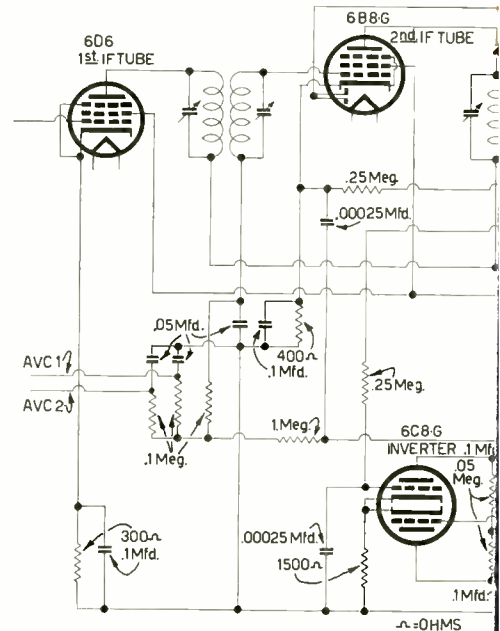

B minus, the cathode is favored by the lower resistor, and the second i-f tube, or amplifier part of the 6B8G, is subject to a.v.c. Thus positive grids of controlled tubes are avoided, during reception, as any signal being received will be of sufficient rectified voltage value to overcome the steady-stage bias on the 6B8G amplifier, and, besides, the steady-state bias voltage is reduced by signal on account of a.v.c. cutting down the plate current on which this bias depends.

Into one of the grids of the 6C8G (upper section in diagram) is put the audio signal, as taken from the volume control potentiometer, and, assuming a required plate load resistor of 100,000 ohms, there is developed across it 22 times as great voltage as is present at the input. This is due to the amplification in the circuit, ascribed completely to the tube. So if we divide a theoretical 100,000-ohm resistor so that it exists as a total but permits tapping off at 1/22 full value, then we have a voltage low

Push-Pull Audio Drives Output Tubes

C. Wyndham

The 6B8G used as combination diode second detector and a-v-c supply, the rectified output being delivered to a 6C8G phase inverter, which drives output tubes that do not require more than 20 volts negative bias. Distortion at detector output, for full loading of the push-pull stage, is considerably less than one per cent.

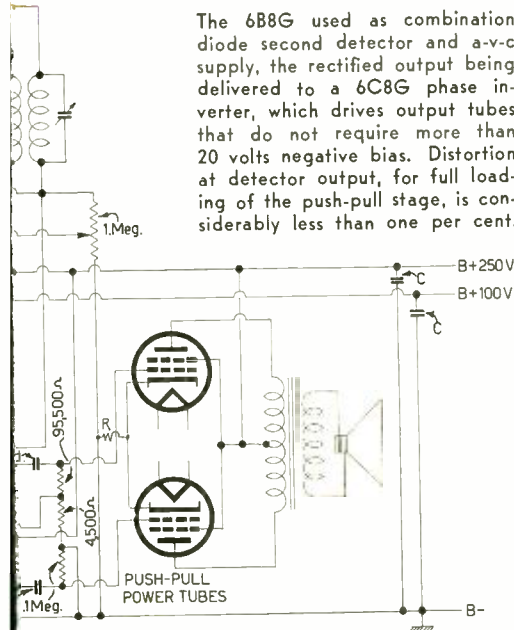

have a phase inverter that will take about as much swing as the power tubes of medium variety. In other words, we may now swing power tubes in the 40-60 volt negative bias class, and operate high-powered sets.

The infinite impedance diode is used as was shown, except the condenser bypassing the .1 meg. resistor at left cathode leg of the 6C8G should be .00025 mfd. and not 25 mfd. In the right-hand cathode the 25 mfd. designation is correct.

Now, instead of output going "To Power Tube Grid," it goes to grid of the 6C8G inverter, directly and not through an extra resistor, and the rest of the circuit is as shown in the first diagram, from inverter tube on. The resistor R in the first diagram, for biasing the output tubes, is now larger, and its value is obtained from tube manuals.

The only precaution is to apportion the voltages properly, to get zero difference in amplitude at output of the inverter. This may be done with a tube voltmeter, or by dividing into the recommended plate load resistor by the amplification factor, for one resistor, and using the difference in resistance for the other, as before.

Eight Therapeutic Uses Listed for Short Waves

Speaking to a recent meeting of the American Institute, in New York City, Samuel G. Hibben, director of applied lighting, Westinghouse Electric & Mfg. Co., broadly outlined uses to which short-wave electrical radiation may be put:

1. Sterilization of liquids, such as water and milk, and of many other food products.
2. Sterilization of containers in cases where high temperatures cannot be used.
3. Reduction or control of mold or fungi, as on seeds and bulbs, foods, and wall surfaces.
4. Treatment of certain superficial skin diseases.
5. Partial or perhaps entire sterilization of air, in connection with air conditioning and dust precipitation.
6. Preservation of certain foods against decay.
7. Speed-up of plant germination and characteristics, accompanied by electric soil or surface heating.
8. Sterilization of hospital areas during delicate operations.

enough) to be fed into an equal tube, at the grid circuit, and come out at equal voltage to the other output. So we need $100,000/22$ or 4,500 ohms, and, to institute full 100,000 we need also the difference, or 95,500 ohms, and these values are present in the diagram. Thus, from one section of the inverter tube we get no gain. We simply get the required phase shift of 180 degrees. We get gain from and use gain from one section and go on to the push-pull stage. We get, but hardly can say we use, gain from the other, because we have reduced the input to offset the gain. Our requirement is that the voltages be equal but opposite, therefore we cannot have two values of voltage, only a single value.

Now, if we are using an infinite impedance detector circuit, as shown in last month's issue, for the present purpose we prefer to use low μ triodes, so that they will stand a good swing. Say we select 76's or 6C5's, or a twin triode tube of low μ . Now we shall

BETTER PERFORMANCE

On Short Waves with an Improved Converter Tube

By Alexander C. Woodstock

THE tube manufacturers are contributing a great deal to the improvement of receivers, as perhaps they well may, as some of the very shortcomings they seek to redress are due to tubes. Therefore in the cleanup campaign they may be doing no more than their own washing.

Recently we have witnessed developments in power output tubes for receivers, the beam type tubes being particular examples, affording added zest without requiring extra voltage, although, as may be expected, they draw con-

Now we find considerable attention being given to making shortwave listening more enjoyable.

The public interest in short waves is only a few years old, but has resulted in the requirement that console receivers be of the all-wave type, or at least cover two bands, the standard broadcast and the foreign short-wave. It is highly advisable, for the sake of all who make their living in radio repairing, or in the manufacture and sale of receivers, that the public be kept deeply interested in short waves. There is an abundance of invitation to accomplish this end, but the means is not so easy.

HIS FIRST EXPERIENCE

For instance, it often happens that a person buys a receiver that tunes in short waves, his first experience in that field. He has heard so much about them. Programs from foreign countries come in clearly. It is such fun to explore the ether, with no national or even international boundaries, where every continent is within reach of the armchair.

Then the fun begins. Some patience in tuning is required, although much less now than formerly, because dial mechanisms and electrical bandspread take up the difference. Then there are assorted noises, more plentiful by far on short waves than on the standard broadcast band, which is as quiet as can be expected, and far more than passable in that respect.

Even some of the short-wave stations tuned in are mistaken for stray noise—automatic transmitters, for instance. Then fading, motorboating and other troubles are experienced, particularly disappearance of sensitivity at frequencies above 10 mc. If the customer's imagination, or his sense of romance, can override these shortcomings with which receivers are afflicted, or which may be considered in

some respects concomitant with short-wave transmission and reception generally, then, with some good breaks at foreign catches, he can be relied on to retain interest in short waves and contagiously stimulate friends to a comparable sales-inducing interest.

The usual happening probably is quite to the contrary. After a couple of weeks at short-wave trials the set owner returns to his first love, the standard broadcast band, and scarcely ever does a hand molest the bandswitch knob. Short waves may be all right for some, but not for him. And so to bed.

HOLDING UP HOPE

All the difficulties attended on short-wave phenomena can not be solved at once, and not all by the tube manufacturers, now or hereafter, but to these manufacturers we are indebted for improvements introduced as quickly as could be expected after the causes of the troubles were ascertained.

One very serious shortcoming is motorboating, due to frequency shift of the local oscillator in a superheterodyne. When the frequency is high, say, above 15 megacycles, this trouble is most pronounced, because small equivalent capacity changes produce large frequency changes. Thus it has been known that a receiver tuned to one station would tune itself to another station and back to the first station, without anybody molesting a dial or even getting anywhere near the set. Spooks?

If the line voltage changes, the plate voltage on the oscillator changes, likewise the oscillation intensity and the bias, and all these augment frequency shift or drift. Actually the first result is that the intermediate frequency is changed, meaning the frequency ejected by the mixer. If it changes back and forth fast enough there is a fluttering effect, but if there is a drift, or slow change, there may be a semblance of slow fading, even so extensive that one station fades out and another fades in. This unchosen multiplicity of reception is particularly vexatious to the novice in short-wave radio who is experimenting hopefully with the knobs of his new receiver. No hopes should be dashed.

Besides the special cases of distortion just mentioned, just general distortion, in the form of disagreeable reception, may result from frequency drift.

It was only natural therefore that the tube manufacturers should try to improve conven-

tional tube design to avoid the troubles that convention developed.

MAKESHIFTS USED

Meanwhile set manufacturers, not being tube manufacturers as a rule, had to contend with means at their command with existing tubes, and resorted to much makeshifts as omission of automatic volume control from the high-frequency band (say, 6 to 22 mc), the very band where it was needed most but couldn't be introduced without providing a remedy that was more obnoxious than the ailment.

The object of a. v. c. is to keep the output of the second detector steady, so that the only changes will be those introduced by the purposeful modulation.

It so happens that the pentagrid converter tubes of popular use do not work so well on a. v. c. at high frequencies, because of the resultant change of biases occasioning change of frequency, by alteration of the plate impedance.

The plate impedance may be considered as a resistor, and since there is capacity associated with all tubes, also some introduced by external circuits, the resistor may be deemed in series with a capacity. Naturally, the lower the resistance, the greater the effect of the reflected capacity on the tuning. If the resistance is wobbling the oscillator is frequency modulated.

USE OF BALLAST TUBE

If the change in frequency is due to change in the voltage of the power supply, it is possible to use a ballast tube to keep the voltage on the tube practically constant.

But those two—avoidance of a. v. c. and use of ballast tube as stabilizer against drift—are makeshifts, because the trouble is fundamentally in the mixer tube, and a solution is to use a high impedance type mixer that stands a. v. c. on the modulator grid. Such a tube is the 6L7, for instance, but commercial requirements call for a two-in-one tube, like the 6A7, without the troubles attendant on the 6A7. Equivalent tubes to the 6A7 are the 6A8 and 6A8G.

The improved tube has been produced. It is the 6J8G, a triode-heptode converter. A triode is a three-element tube and a heptode is a seven-element tube.

FACTS ON NEW TUBE

The idea of a triode oscillator and a multi-grid mixer originated in Europe, as set forth in "Engineering News Letter No. 45," prepared by engineers of Hygrade-Sylvania Corporation. The attainment with this tube equals that of the use of a separate oscillator and a separate modulator.

In the design of this tube the two considerations that most afflicted the set manufacturers, frequency drift and relatively low gain on the short waves, were kept prominently to the fore, and the solution arrived at by combining high plate impedance with minimum input loading. Reporting on the measured results of the

6J8G, compared with the 6A8G, Hygrade-Sylvania sets forth:

"Automatic volume control, when applied to the control grid of the new heptode mixer, will not materially affect the frequency of the oscillator section. For fairly large values of a-v-c voltages the frequency drift of the 6J8G is less than one twenty-fifth that of the 6A8G. Data were taken at 18 mc, using a conventional tuned-grid, shunt-fed oscillator."

BETTER ATTENUATION

Attenuation of the signal is more effective with the 6J8G. The conversion conductance of the tube drops to a low level, when affected by a. v. c., without resulting in any pronounced frequency drift.

Remembering that the measurements were taken at 18 mc, the frequency drift of the new tube, for a line voltage change from 115 volts to 100 volts, or a difference of 15 volts, was less than 2 kc. The 6A8G under the same conditions could cause a change of 20 kc. The same reflected frequency change takes place if the line voltage is changed the same amount in the opposite direction.

Since 2 kc equals .002 mc, the change therefore is $100 (18 \div .002) = .01$ per cent. For the 6A8G the percentage would be .1 per cent.

High plate impedance in the new tube is obtained through the use of a suppressor grid. It is therefore practical to use high-impedance antenna coils without draining the i-f circuit of its input selectivity. At standard broadcast frequencies the per stage gain and the translation gain may will be about the same for the two tubes, 6J8G and 6A8G, but when it comes to short-wave operation, only the new tube retains the same performance as on the standard broadcast band, whereas the other tube falls off perceptibly.

Sylvania has plotted a curve, comparing conversion conductance in micromhos with oscillator grid current in milliamperes, when a 50,000-ohm leak is used in the 6J8G triode grid circuit. The conversion conductance attains maximum at .25 ma = 250 microamperes grid current, and for larger grid currents to .9 ma = 900 μ a, does not change greatly. But for values less than 250 microamperes the loss is large. Therefore for all services the grid current should be at least 250 microamperes, which causes the tube to be worked above the knee of the curve.

HAZELTINE LICENSES RCA

Radio Corporation of America has entered into agreements with Hazeltine Corporation whereby it has acquired non-exclusive licenses in all radio fields under the Hazeltine patents. These agreements terminate litigation.

MAE WEST BROADCAST CONDEMNED

Washington

The Federal Communications Commission condemned the broadcast of a travesty of Biblical incidents, "Garden of Eden," made on a recent Sunday night over a National Broadcasting Company network by Mae West.

EDITORIAL

THE difficult task of subjecting the radio industry to a house-cleaning is getting under way. The Federal Trade Commission has drawn up a set of trade practice regulations, concerning which hearings are held before anything is put into effect. The scope of the tentative rules is wide, but various radio groups want to make it wider, or, in some respects, narrower. Agreement in the radio industry is always the easiest impossibility.

Purifying the radio business is difficult because there are so many of the smaller-sized enterprises with which little headway could be made even by NRA, and not too much accomplished even now in the collection of the radio tax. They are the inert gases. Experts at outsmarting a competitor are not dismayed even at taking a few innocent passes at the Federal Government. Some of the large concerns are not models of propriety in all respects, either, but are quicker to feel a repressing finger. They secretly or openly promote some of the worst evils in the industry, but some show signs of remorse.

The general idea of the trade practice regulations is to compel honest and truthful advertising of receivers and parts, stop the dummy tube exploitation, prohibit the distribution of push-money to store salesmen to belittle sets made by other companies, so as to curtail competition and induce the customer to buy the sets that carry the pin money; compelling frank marking of sets; definitions of uncertain terms, as "all-wave," and "world-wave," prevention of tampering with serial numbers, and masquerading orphan sets under established names, especially of concerns that have gone out of business.

Naturally, as soon as anything is mentioned concerning fair trade practices, every one with a grievance wants to have the proposed code so framed as to make business life more comfortable to him. Since the Commission invites suggestions, it is bound to get plenty of them from an industry in which nobody is satisfied with the way things are.

It was not to be expected that the serviceman would be omitted. True, nothing in the code bears on how he shall conduct himself in the repair of a set, not even a word against removing whatever is of value, and substituting inferior parts, to improve the "take" on a job. But it is a fact that dealers have noticed the increased growth of set sales by servicemen, some of whom have the receivers on display in their shops.

The discount situation is as bad as it has always been, and is a sort of characteristic of the radio business. The Blue Book Committee, Radio Dealers Association of Metropolitan New York, points out, in a letter to the Commission, that discounts are too high, dealers offer too great trade-in allowances on old sets of small value, competition is great for big trade-in "allowances," and the market is continually disturbed. Results aimed at in Greater New York would apply nationally if a national dealer association were formed, the committee sets forth, and other difficulties in the industry could be attacked. With lower discounts and standard trade-in values, list prices would be reduced.

"Remedies would include," says the committee, "elimination of the discounts frequently offered in a 'confidential' way by big city dealers to blocs of employes of large concerns; ending the practice of selling merchandise to repair men at trade prices; and wiping out the condition of over-competition between manufacturers in which they establish and overload too many dealers, resulting in heavy price sacrifices on the part of the dealers in an effort to meet their obligations, so bringing on trade demoralization."

So the serviceman is not entirely left out of the picture, as here is an argument against giving him trade discounts; nor is it at all foreign to his interests that there should be an attempt to clean up the industry. So the Commission, in whatever it does, will have to do as it deems best, in the face of a disunited front among those whom the code will affect. There is no mistaking the fact that the Commission will have to act against the very ones to whom it listens, and against those who address communications containing all sorts of suggestions. Dealers who want to be reputable therefore must be participating in evils with most reluctant compulsion.

To single out one controversial point, the Commission proposes to prohibit private brand receivers, whereby one company makes a set, and another company sells it under a trade name not at all associated with the real maker, and the public is led to believe the owners of the trade name make the set. The private brand practice permeates many industries, and why it should be misfeasance in one industry and patriotic endeavor in another is hard to appreciate. Anyway, the radio trade itself is not in full agreement, most manufacturers, but not all, opposing the prohibition, while groups favoring it include those watchful of business ethics, for they have seen the overdone side of the private-brand radio.

The majority in the radio and servicing business are reliable and ethical. The drive is against the disturbing and evil minority.

THE DECIBEL EXPLAINED

In Simple, Every Day Language

A SHORT article in the December, 1937, issue, entitled, "What Are Decibels, Anyway?" provoked considerable correspondence from readers. One letter, from R. K. Wheeler, published last month (January issue) stated decibels were unimportant to servicemen, but gave a convenient birdseye view of the decibel so that a non-mathematical person could understand it.

Another reader quarreled with the statement in the original brief article that since decibels and ear response are logarithmic, "twice as many decibels up means doubled sensitivity to sound." Of course, this is not strictly true, nor is there agreement on the decibel change that does produce twice the ear response. But it should be remembered the ear response was being considered, and not power, for, as the reader pointed out, the power consideration would lead to vastly different values.

EXPRESSES GAIN OR LOSS

Of considerable interest in connection with decibels is a simple explanation given by F. H. Best, of the Transmission Development Department, Bell Telephone Laboratories, in an article entitled, "Decibel Meters." It appeared in the January, 1937, issue of "Bell Laboratories Record." The article described a Laboratories product, a meter with linear decibel scale. The brief history of the decibel is set forth by Mr. Best as follows:

"During the present century there has come into existence a new unit known as the decibel. It was employed originally as a measure of loss and gain in telephone transmission, but because of its wider utility, it has more recently been adopted by other electro-acoustic fields such as broadcasting and sound pictures, and is also used in the measurement of noise and sound in general. Regardless of its field of use, however, it remains a measure of an increase or decrease in power, but it is a unit of an unusual type, and in spite of its wide employment has remained more or less of an enigma to all but those who are initiated in its use.

IN ORDINARY AFFAIRS

"In the ordinary affairs of life a change in anything would be measured either in the same units as the original quantity, or in per cent of the original. If, for example, a man buys a bond for \$1,000 and sells it for \$900, his loss might be said to be \$100 or 10 per cent. Both of these measures of loss are significant: the first giving the actual amount of money lost, and the second the ratio of loss to original principal. Such methods of measuring loss are also used in many other fields, such as in electric power transmission, for example.

"Neither of these methods, however, is

entirely, satisfactory for measuring losses in telephone circuits. Such circuits are designed so that a given circuit element produces the same percentage loss between its input and output terminals regardless of the part of the circuit into which it is inserted. Since the input in watts to such an element varies with the location of the element in the circuit, the loss in watts produced differs for each position of the element, and so to measure the loss in watts would be to lose the advantage of a single and constant expression for the loss occasioned.

A SERIES CONVENIENCE

"While an expression of the loss in per cent would not be open to this objection, it becomes inconvenient when the effect of a number of such elements in series is to be considered. If R, for example, be allowed to represent the ratio of capital after investment to capital before, or of power at the output terminals of a circuit element to power at the input terminal, the per cent loss is given by the expression $100(1-R)$, and where several losses are suffered consecutively, the combined loss in per cent becomes $100[1-(R_1 \times R_2 \times R_3)]$ where R_1 , R_2 and R_3 are the loss ratios for the various elements. The calculation of such a combination of losses is complicated by the series multiplication.

"In the db system the same loss ratio R is employed, but the series multiplication is avoided by using the logarithm of R as the unit of loss instead of the ratio R itself. It takes advantage of the simple mathematical fact that the $\log (R_1 \times R_2 \times R_3)$ is equal to $\log R_1 + \log R_2 + \log R_3$. A circuit element producing a loss ratio R is said to produce a loss of X bels, where X is the logarithm of R. The total loss produced by a number of elements is thus the sum of the losses of the individual elements. More commonly the decibel is used instead of the bel, and since a decibel is 1/10 of a bel, the loss in decibels is $10 \log R$ instead of simply $\log R$. The logarithm of ratios of 0.1, 0.01, 0.001, etc., are whole numbers, and thus the db loss for these respective loss ratios are 10, 20, and 30 db which correspond to percentage losses of 90, 99, and 99.9.

AN EXAMPLE

"If, for example, three circuit elements produced loss ratios of 0.5, 0.4, and 0.3, the combined ratio would be $0.5 \times 0.4 \times 0.3$ or .06 and the resultant loss would be 94% or 100 (1-.06). Expressed in the db systems the individual losses would be 3.01, 3.98 and 5.23, which are ten times the respective logarithms of 0.5, 0.4, and 0.3. The overall loss would simply be the sum of the individual losses, or $3.01 + 3.98 + 5.23 = 12.22$."

PHOTOTUBE OPERATION

Gas and Vacuum Types Compared, Methods Revealed, and Candlepower of Lamps Tabulated

THE behavior of a phototube for given operating conditions can be predicted from the anode characteristics of the tube. These characteristics, which correspond to the plate family of an amplifier tube, show the relation between anode current and anode voltage for different values of light input. It is the purpose of this Note to show how the anode characteristics of a phototube can be used to

predict performance under given operating conditions.

The solid-line curves of Fig. 1 are the anode characteristics of a typical vacuum phototube having a caesium-oxide coated cathode. When a small amount of inert gas, such as argon, is admitted to the tube, the anode characteristics of the phototube change to those shown by the dashed-line curves of Fig. 1. The dashed-line curves are typical of gas phototubes. These two sets of curves will be used in this Note to illustrate the performance of gas and vacuum phototubes.

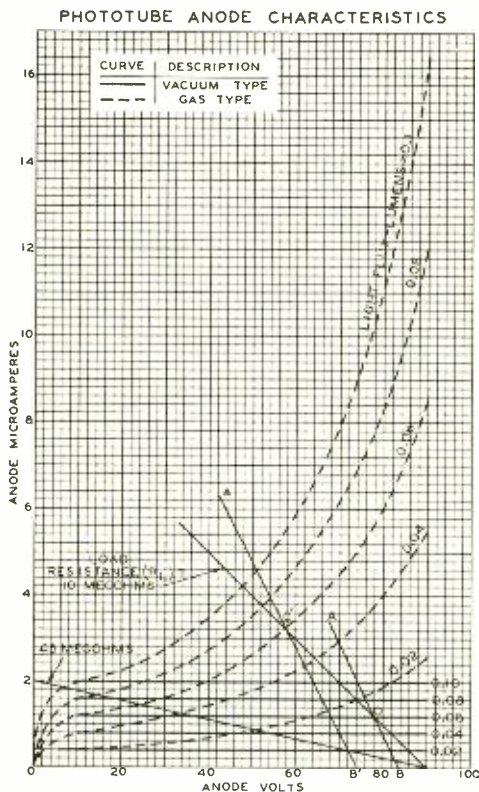

FIG. 1

The solid-line curves are the anode characteristics of a typical vacuum phototube having caesium-oxide coated cathode and correspond to the plate family of an amplifier tube. The dashed-line curves are typical of gas phototubes.

STEADY-LIGHT OPERATION

Fig. 2A is a typical phototube circuit in which the output voltage appears across resistor R_L . When light falls on the cathode of the phototube, a current flows through R_L and the phototube; at any instant, the sum of the voltage drops across R_L and the phototube equals E , the applied voltage. Hence, the voltage across R_L and the voltage across the phototube for any value of light input can be determined by the intersection of a load line and the anode characteristic of interest. For example, when $R_L = 10$ megohms, $E = 90$ volts, and $F = 0.04$ lumen, the voltage across R_L is 25 volts for the gas phototube and 8 volts for the vacuum phototube. When $R_L = 45$ megohms, the output voltage is 56 volts for the gas type and 37 volts for the vacuum type. Hence, as R_L is increased, the output voltage of the vacuum type approaches that of the gas type. The effect of load resistance on output voltage for a given value of light input is shown in Fig. 3.

The circuit of Fig. 2A is suitable for applications in which the d-c output voltage feeds a voltage amplifier which, in turn, actuates a relay. For this type of application, the gas phototube is more sensitive than the vacuum type with the same B-supply voltage and load. However, the sensitivity of gas phototubes changes with age, applied voltage and values of light input. Because of these factors, circuits for gas phototubes should not be critical to reasonable changes in sensitivity. In some applications these changes in sensitivity can be compensated by an adjustment of the gain following the phototube. In the event that readjustment of the gain is not desirable, a vacuum phototube used with sufficient amplification to give the desired overall sensitivity will prove more stable.

Many phototube circuits depend on modulated light for their operation. In a sound-motion-picture projector, for example, the amplifier following the phototube responds only to the modulated component of light input. In such applications, the criteria for sensitivity are not the same as those for steady-light operation.

MODULATED-LIGHT OPERATION

In circuits which depend on steady-light input for operation, phototube sensitivity is simply $S = I_a/F$, where I_a is the anode current in microamperes and F is the light flux in lumens received by the cathode. In circuits which depend on modulated-light input for operation, phototube sensitivity is defined as

$$S_d = \frac{dI_a}{dF}$$

S is the static sensitivity and S_d is the variational sensitivity of the phototube. Variational sensitivity is analogous to the transconductance (g_m) of an amplifier tube. Because the output of the phototube usually feeds a voltage-operated amplifier, it is important to know the voltage sensitivity of the phototube and its associated circuit. Voltage sensitivity (S_v) in this Note is defined as the ratio of the alternating voltage output to the alternating light-flux input. In symbols,

$$S_v = \frac{dE_a}{dF}$$

where E_a is the output voltage in volts. Now, the action of the circuit of Fig. 2A is analogous to that of an amplifier tube: the cathode is a source of electrons and the anode collects these electrons; the varying light input on the cathode is analogous to an alternating voltage applied to the grid of an amplifier tube. Therefore, the alternating output voltage of a phototube is

$$dE_a = dF \cdot S_d \frac{r_p R_L}{r_p + R_L}$$

where r_p is the variational resistance in ohms of the phototube and is equal to the slope (dE/dI) of the anode characteristic at the operating point. Since voltage sensitivity is the output voltage per unit of light-flux input,

$$S_v = S_d \frac{r_p R_L}{r_p + R_L}$$

IMPORTANCE OF APPLICATION

The physical interpretation of this last equation is important. The internal resistance of the phototube shunts the load resistance R_L ; the change in current due to a change in light flux causes a voltage drop across the parallel combination of r_p and R_L . Thus, the output voltage may be low, even though S_d is high, because the internal resistance of the phototube reduces the generated voltage.

The internal resistance of a vacuum phototube is very high, while that of a gas photo-

tube is low over a large portion of its operating range. The value of r_p at a point on any anode characteristic can be determined by measuring the slope at the point of interest. S_d is constant for vacuum phototubes over their operating range, but is not constant for gas phototubes. For this reason, it is desirable to calculate the performance of phototubes by graphical methods. However, it should be noted that for vacuum phototubes the output

PHOTOTUBE OPERATING CHARACTERISTICS

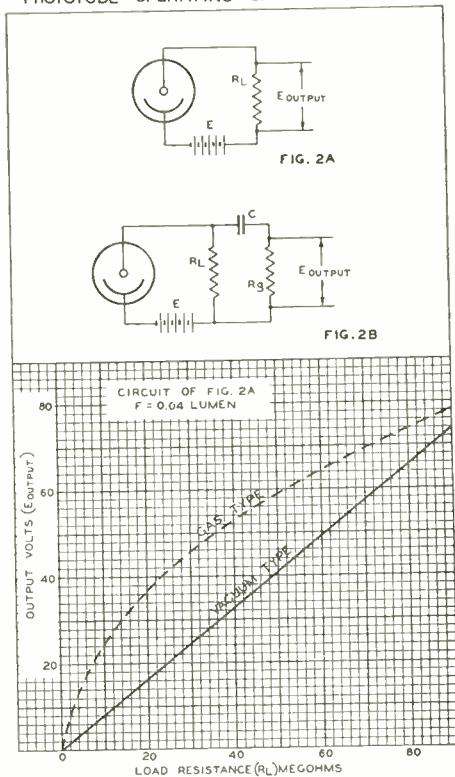

FIGS. 2A, 2B and 3

A typical phototube circuit is shown in Fig. 2A, with output across R_L . In Fig. 2B the charge and discharge of condenser C is also involved. Fig. 3 (lower) gives the effect of load resistor on output voltage for a given value of light input.

voltage can be calculated with fair accuracy by the relation

$$E_a = F S_d R_L$$

where F is the alternating component of the light input in lumens and E_a is the alternating voltage output in volts.

Consider the typical phototube circuit of Fig. 2B. The load is R_L for steady-light input and is the parallel combination of R_L and R_g for alternating-light input, provided the reactance of C is negligible at the lowest frequency of interest. To predict the operation of the phototube when the light input is modu-

(Continued on following page)

(Continued from preceding page)

lated, draw the load line R_L from the B-supply voltage, as shown in Fig. 1. For a steady-light input of 0.06 lumen, the operating point is O for the vacuum-type phototube and is O' for the gas-type phototube.

COMPARISON OF DISTORTION

A convenient value of $R_L = 10$ megohms is assumed. When $R_g = R_L$ and the amplitude

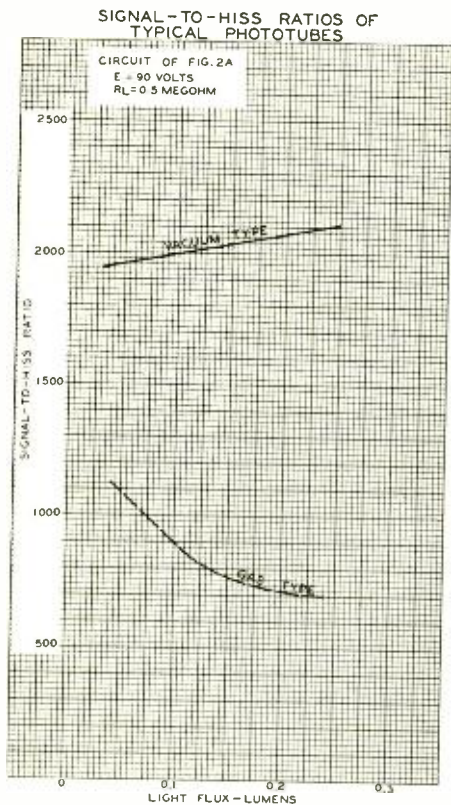

FIG. 4

Since the hiss amplitude itself is not of great importance, but the ratio of signal to hiss, the curves plot the ratios for vacuum and gas phototubes.

of the sinusoidal light input is constant, load lines AB and A'B' represent the operating lines for the vacuum and gas phototubes, respectively. Now, when the steady-light input is modulated 66 2/3%, for example, the peak value of light input is 0.1 lumen and the minimum value is 0.02 lumen; the corresponding changes in voltage across R_g are $(67.5 - 51) = 16.5$ volts for the gas phototube and $(82 - 74) = 8$ volts for the vacuum type. These values are the total changes in output voltage; the peak values of the fundamental components are approximately half these values.

For a sinusoidal variation in light input, the

distortion is negligible for the vacuum phototube and is appreciable for the gas phototube. The second-harmonic distortion may be calculated from the relation

$$\% \text{ 2d Harmonic} = \frac{(I_{\max} + I_{\min} - 2 I_o)}{2(I_{\max} - I_{\min})} \times 100$$

where I_{\max} and I_{\min} are the maximum and minimum instantaneous values of current, respectively, and I_o is the current at the operating point. Substituting the values obtained from Fig. 1 for the gas phototube, we have

$$\% \text{ 2d Harmonic} = \frac{4.6 + 1.3 - (2 \times 3.2)}{2(4.6 - 1.3)} \times 100 = -7.5\% \text{ (approx.)}$$

The sign of a harmonic indicates its phase; the negative sign in this example signifies that the average value of the anode current is less with modulation than without modulation. This simple analysis shows that for chosen values of R_L , R_g , and E, and with the same B supply voltage, the gas-type phototube furnishes about twice as much output as the vacuum type; however, the output of the gas type may contain too much distortion for some purposes.

WHEN THE TWO ARE ALIKE

A comparison of the anode characteristics of the two types of phototubes shows that for very large values of load resistances corresponding to the light flux on the cathode, the performance of both types is identical, because the sensitivity of the gas phototube approaches that of the vacuum phototube at low values of anode voltage. When R_g is infinite, the calculations for output voltage and distortion are made along the load line corresponding only to R_L .

The recommended maximum anode voltage for a gas phototube is 90 volts. When the anode voltage rises above 90 volts, a glow discharge takes place and the active emitting surface of the cathode sputters off. Thus, the peak value of the maximum alternating output voltage from a gas phototube is limited to a little less than 90/2, or 45 volts.

The recommended maximum d-c anode-supply voltage for a vacuum phototube is 500 volts. In order to obtain the maximum voltage output from a vacuum phototube supplied with modulated light, it is necessary to adjust the anode voltage under static conditions to a value approximately one-half of the maximum d-c supply voltage. This adjustment permits the modulated voltage output to have a peak value of nearly 250 volts.

From this discussion, it is seen that when the respective maximum anode voltages are applied to each type of phototube, and when the value of the load on the vacuum phototube is increased until the minimum instantaneous anode voltage (E_{\min}) is the same for both types, the voltage sensitivity of the vacuum phototube can be much higher than that of the gas type. In

the limiting case when maximum output voltage is obtained from each type for the same value of light input, the voltage sensitivity of the vacuum phototube is approximately 250/90, or 2.7 times that of the gas phototube.

SENSITIVITIES AFFECTED

The static and variational sensitivities of gas phototubes vary with age, temperature, light-flux, and anode voltage. In applications where changes in sensitivity necessitate readjustments of circuit conditions, consideration should be given to the use of vacuum phototubes. It is easy to compensate for the comparatively low gain of vacuum phototubes under certain operating conditions by increasing the gain of the succeeding amplifier.

A good frequency characteristic is desirable in many cases. When a vacuum phototube is used, the anode-cathode capacitance of the phototube and the equivalent shunt capacitance of the associated circuit determine the high-frequency response characteristic. When a gas phototube is used, the time necessary to deionize the gas is also a factor in determining high-frequency response. The relative magnitudes of the effects of capacitance and gas on high-frequency response depend on the physical placement of the components and their electrical characteristics.

The absolute value of hiss output is in general not as important as the signal-to-hiss ratio. The data in Fig. 4 show the relation between signal-to-hiss ratio and light flux for typical vacuum and gas phototubes. When it is desirable to have a large signal-to-hiss ratio, the use of a vacuum phototube may be preferable.

DETERMINATION OF LIGHT FLUX

The success of any method for predicting the performance of a phototube depends on the accuracy with which the light flux received by the cathode is known. The light flux in lumens on the cathode can be determined when the candlepower of the light source, the distance between light source and cathode, and the area of the light spot on the cathode are known. The light flux, F, in lumens, is

$$F = \frac{(CP) A}{144 R^2}$$

where (CP) is the average candlepower in candles of the light source; A, the area of the light spot on the cathode in square inches; and R the distance in feet between the light source and the phototube. This formula should be used only when R is much greater than the largest dimension of the light source.

In most applications, it is necessary to shield the phototube from extraneous light; a small aperture, about 0.5-inch in diameter, admits the light that actuates the tube. For a light spot of this size, the value of F becomes

$$F = 0.00137 \frac{(CP)}{R^2}$$

TABLE FOR LAMP CP

The following table lists the approximate

SETS IMPROVED, BOARD REPORTS

Washington

Marked improvements in radio receiving sets, but with television and facsimile declared officially as not yet ready for commercial introduction, are detailed in the annual report of the Federal Communications Commission which has just been presented to Congress. After stating that there has been considerable technical development in both television and facsimile during the past year, but that "it is still generally conceded that neither has reached the stage of development that will permit standardization and commercialized operation," the Communications Commission's report noted special improvements in the new 1937-38 receiving sets.

"There have also been several developments in broadcast receiver design (directed mainly to improve the ease of manipulation or the fidelity of reproduction), two of which are automatic tuning and volume-expansion circuits," the Commission report recited. "Receivers so equipped have improved the quality of reproduction by the elimination of the distortion and interference due to improper tuning and by an increase extension of the volume range."

candlepower rating of a number of standard inside-frosted Mazda lamps which are not surrounded by reflecting surfaces.

TABLE I

Watts	Bulb Designation	Initial CP (Approx.)
15	A-17 I.F.	—
25	A-19 I.F.	—
40	A-19 I.F.	34
50	A-19 I.F. (Rough Service)	35
60	A-21 I.F.	60
75	A-21 I.F.	82
100	A-23 I.F.	120
150	A-25 I.F.	200

Under "bulb designation," the first letter indicates the shape of the bulb, the following number is the maximum diameter of the bulb in eighths of an inch, and the letters I.F. signify inside frosted.

HEADLIGHT QUALIFICATION

In the case of automobile headlight lamps, the rated value of candlepower obtains for the direction which is perpendicular to the plane of the filament.

A value of light flux obtained from these data is approximate and should serve only as a guide. Final values of circuit constants should be based on tests with the equipment operating over the expected range of line-voltage variation.

Copyright, 1937, by RCA Manufacturing Co., Inc.

AN AMPLIFIER THAT LIMITS VOLUME

**Applied to Transmitter, It
Enables Doubling Rated Power
Output by Over-Modulation Control**

By O. M. Hovgaard

Radio Development, Bell Telephone Laboratories, Inc.

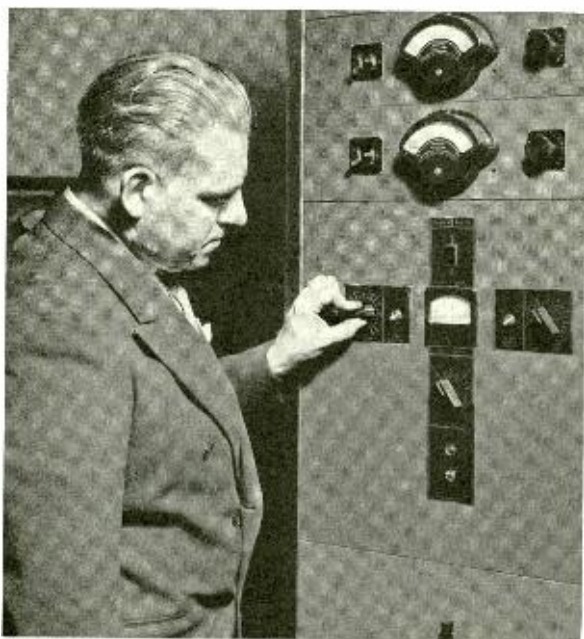

FIG. 1

The volume-limiting amplifier, which puts an automatic check on over-modulation, and permits effectively doubling the rated carrier power of a transmitter, is housed in the lowest panel. Relay-rack mounting permitted compact self-containment. The terminating impedances are 600 ohms.

PROBABLY no single factor is of greater economic importance to radio broadcasters than the level of modulation of their radiated program. For a given carrier power the level of modulation determines the area over which a program is heard, and thus approximately the population reached. More listeners, of course, mean a greater response to the advertising appeal and thus a greater potential income, so that the economic importance of a higher modulation level is obvious.

On the other hand, distortion is caused by over-modulation, and increases rapidly as the program level is raised. Program peaks which exceed the level for complete modulation generate harmonics and cause interference with other programs on adjacent channels as well as

distortion of their own program. As a result one of the important functions of a monitoring operator in maintaining the highest practicable program level is the manipulation of the circuit gain so as to prevent over-modulation during program peaks. In this he is guided by a level-indicating device, and frequently has the benefit of program rehearsals, but human limitations rather than the level-indicating means usually determine the maximum general program level that can be maintained by the utilization of this method.

A NEW DEVICE

To obtain maximum level with greater assurance of freedom from over-modulation, a new volume control device has recently been devel-

oped. It is known as the Western Electric 110A program amplifier, and is based on a circuit developed by the research department. The original circuit was modified, however, to permit operation from the usual 110-volt, fifty- or sixty-cycle a-c power supply, and was arranged to be completely contained in a relay-rack mounting cabinet as shown in the lower panel in the photograph, Fig. 1. The terminating impedances are 600 ohms, and the overall gain is 55 db. The transmission-frequency

rectifier, the grid potential of the control tube will remain zero, and the control current, and hence the loss through the volume-control network, will remain constant. If the level rises above the bias on the rectifier, however, the bias on the control tube will become negative. This causes the control current to decrease, thereby inserting loss in the program circuit.

For program levels sufficient to overcome the rectifier bias, the growth of potential across the condenser *c* will lag behind the growth of the

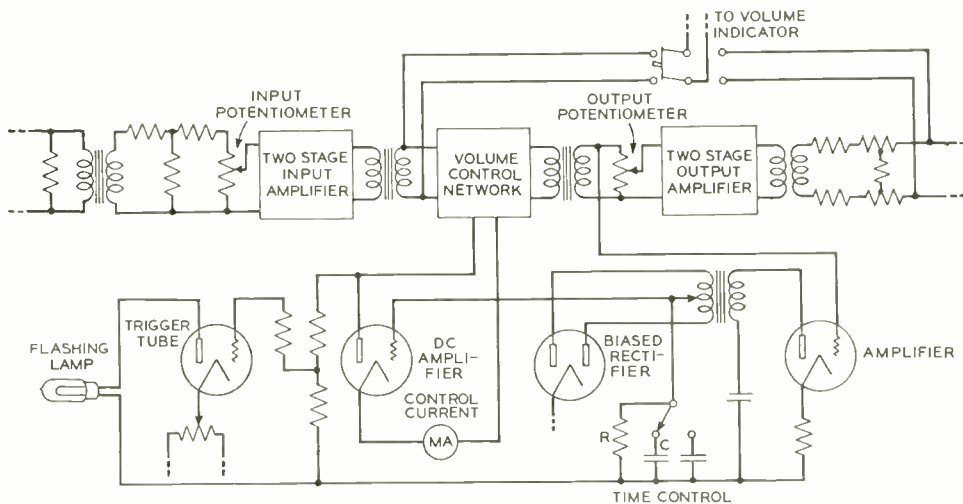

FIG. 2

Simplified schematic of the 110A program amplifier circuit.

characteristic is held flat to within one db from 30 to 10,000 cycles. This new volume-control device can be used with input levels in the range from -35 to +5 db, and output levels from -7.5 to +20 db can be obtained. These levels are for a single-frequency steady-state tone referred to six milliwatts, and adjustments are effected through fixed pads supplemented by input and output gain controls, each of these controls having nineteen one-db steps.

Fig. 2 is a simplified semi-block schematic of the 110A program amplifier, and shows the volume-control network interposed between the input and output amplifiers, and their associated pads and gain controls. A portion of the output from the volume-control network is amplified and applied to a biased full-wave rectifier.

HOW CIRCUIT WORKS

Whenever the applied signal exceeds the bias, a d-c potential appears across the condenser *c* of a time-constant network formed by *c* and *R*. This is applied to the grid of a d-c amplifier, acting as a control tube, and the plate current of this tube, in turn, flows through the volume-control network, and determines the loss through it.

As long as the signal level remains below that necessary to overcome the bias on the

corresponding signal potential. Similarly a decrease of potential across *c* will lag behind the corresponding decrease in the program level. These time lags are determined by the constants selected for the time-control network.

CHARGE AND DISCHARGE

During periods of signal growth, the condenser *c* is charged through the resistance of the rectifier and voltage source in series; during periods of signal drop it discharges through the resistor *R*. Fig. 3 shows the voltage-time relationship for a condenser charged through a resistor. The applied voltage is assumed to be a constant potential, and the time for complete charge is taken as that necessary to bring the potential across the condenser to 99 per cent of the applied voltage. The same curve also gives the conditions during the discharging cycle, in which case the ordinates indicate the percentage of the initial potential which has been removed, on the assumption that the charging potential was shorted at time $t = 0$. The curve is for static conditions with a constant applied potential, and thus represents a limiting case, but it is convenient for the purpose in hand.

With increasing or decreasing potentials, curves of different shapes would be obtained, (Continued on next page)

(Continued from preceding page)

but all of them would lie below and to the right of the one shown. C and R have been selected so that if a steady-state single-frequency tone is applied to the rectifier, the potential across c

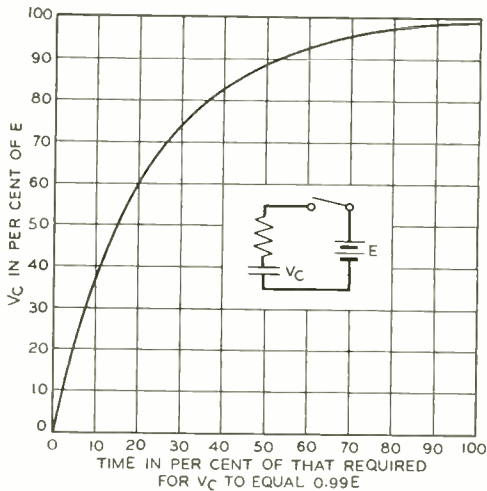

FIG. 3

Charging curve for the time-constant circuit.

will reach a value corresponding to the peak value of the signal wave, and will remain at this value as long as the signal remains. This basis will cause a corresponding change in the plate current of the control tube, and thus cause the insertion of a fixed amount of loss.

THE LEVELS COMPARED

An input-output characteristic of a 110A program amplifier, obtained by varying the input level of a steady-state single-frequency tone, is shown by the curve ABD on Fig. 4. B is the input level necessary to overcome the rectifier bias, and BC is the extension of the linear portion AB of the characteristic. At any input level greater than B , the vertical distance between BC and BD is the amount of loss which has been inserted. If for instance a steady-state tone of peak value $+12$ had been applied, about 5.5 db of loss would have been inserted. Since the potential across the condenser c remains at a steady value, the loss remains fixed and the operating characteristic for the cyclic variations of the tone will be the straight line MN . The curve BD is therefore the locus for the end points of a series of linear input-output characteristics whose location depends upon the peak value of the applied signal.

With voice or music, where the signal varies rapidly in intensity, the location of the input-output characteristic will depend upon the magnitude of the signal peak, its duration, the wave shape, and upon the constants of the time-con-

rol network. These must be selected with due regard for the application for which the amplifier is intended.

Since the primary purpose of the device is to prevent over-modulation by program peaks, the time required for the insertion of loss must be sufficiently short to permit these peaks to be materially reduced. On the other hand, it must not be so short that the sudden stoppage in signal growth becomes noticeable to those listening to the program.

NOT TOO LONG OR SHORT

The time needed for removal of loss must be made long enough so that the loss-control network will not follow cyclic variations in the program at the lowest frequencies which it is desired to transmit, and short enough so that there will be noticeable growth in the background noise as the program circuit gain is restored during a silent period immediately following a crescendo.

Obviously, the selection of constants for the time-control circuit is a compromise. In the 110A program amplifier these are chosen so that, in the limiting case of Fig. 3, twenty milliseconds are required to insert, and 250 milliseconds to remove, 99 per cent of the loss. Means are provided for selecting either of two values for c ; one giving the above values, and the other giving transient periods approximately half the above.

Distortion due to the action of the control circuit is limited to those portions of the program peaks which exceed the rectifier bias, and then occurs only during the rapid insertion of loss. Even though the removal of loss may take place at levels below that corresponding to the rectifier bias, the distortion that results will be unnoticeable due to the slow rate of removal.

POINT OF INSERTION

In applying the 110A program amplifier to a broadcast transmitter for preventing over-modulation, its location in the program circuit and its adjustment are important factors in determining the benefits to be derived.

Since the level at which the volume-control network commences to vary the circuit gain is fixed by the design, it is desirable to insert the amplifier at a point where the transmission levels are essentially constant regardless of their character or origin. This suggests associating the amplifier with the transmitter, and with this in mind, sufficient gain and flexibility have been provided so that it may serve as the line amplifier connecting the incoming program circuit to the radio transmitter.

The proper adjustment of the operating levels of the amplifier requires a consideration of the characteristics of the volume-control network. From Fig. 4 it will be seen that as the input is raised beyond the level B , the output will continue to rise as shown by the portion BD of the characteristic. This characteristic is for a steady-state single-frequency tone, however, and the dynamic characteristic will lie instead

somewhere in the region between BC and BD, its shape and location being determined by the magnitude of the peak, its duration, the wave shape, and the constants of the time control

Since the volume control network does not act instantaneously, however, the removal of loss is delayed by a period which may be long compared to the duration of the peak that caused its

FIG. 4

A typical input - output characteristic of the program amplifier, with a plot of the control current. A single tone in a steady state was the basis of these curves. The dynamic characteristic will lie somewhere in the region between BC and BD. Shape and duration depend on peak magnitude, duration, wave shape and control constants.

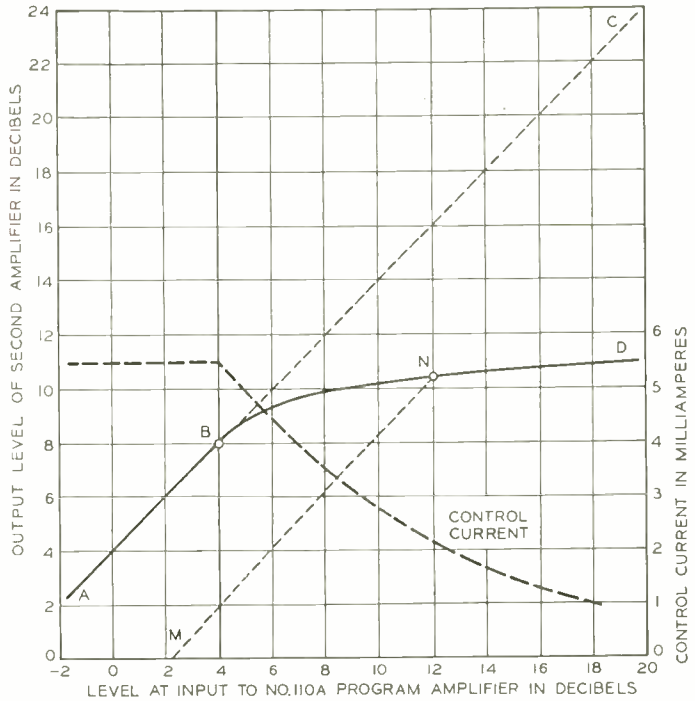

network. If, therefore, the instrument is to prevent serious over-modulation, it must commence to insert loss at levels below that required for complete modulation.

Fig. 5 shows a possible adjustment. An output level of +10 is assumed to modulate the transmitter completely, and the dotted line EF is the input-output characteristic of a conventional line amplifier. ABD is the characteristic of a 110A program amplifier adjusted so that line inputs which gave complete modulation with the conventional amplifier will also give complete modulation with the 110A program amplifier. For the particular conditions shown, loss will be inserted for all levels in excess of that required for about 80 per cent. modulation. For steady-state single-frequency tone about three db will have been inserted at 100 per cent. modulation, and the curve BD flattens out so that a modulation of 108 per cent. is about the highest that can be reached regardless of what the input level may be.

WHEN INCREASE IS OBTAINED

As compared with the conventional line amplifier, the use of the 110A program amplifier results in an increase in the general program level somewhat less than the loss inserted at complete modulation. For the conditions assumed for Fig. 5, it is evident that the output level is three db higher than it would be with a conventional line amplifier up to the point B. From this point to an input level of six db, where the two curves cross, the increase in general level decreases from three db to zero.

insertion, and as a result the increase that is obtainable in the general program level cannot be realized during the intervals of loss removal.

The portion of the total time during which an increase can be obtained depends upon the number and distribution of peaks and their duration, which factors are in turn determined by (Continued on next page)

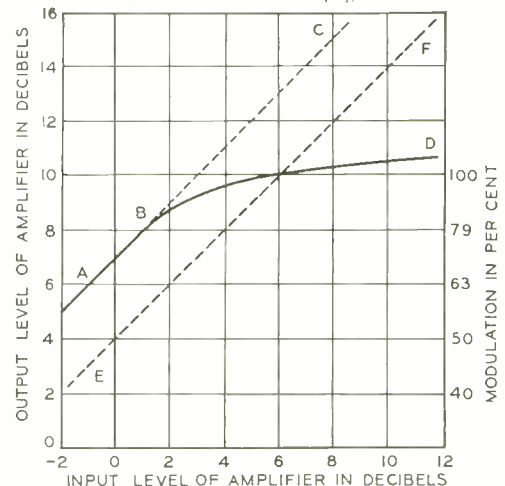

FIG. 5

With the program amplifier in the circuit the general program level is raised by an amount equal to the loss that is inserted at full modulation.

Electrolytic Condensers

The Theories of Operation, Methods of Manufacture and Testing, Also Uses

By Paul McKnight Deeley

Chief Engineer, Electrolytic Division,
Cornell-Dubilier Electric Corporation

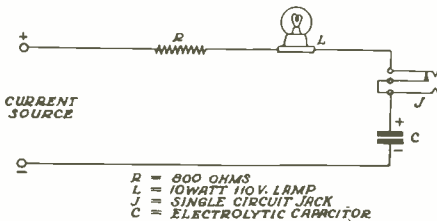

FIG. 1

Overheating is prevented by the resistor R in this circuit for aging electrolytic condensers.

Following are first two chapters of "Treatise on Electrolytic Condensers," the first of four installments. The remaining chapters will appear in the March, April and May issues.—EDITOR.

HISTORY

The electrolytic capacitor is, in reality, a comparatively ancient piece of electrical apparatus, as old, in fact, as the discovery of the decomposition of water in the electric cell.

In the early seventeenth century it was found that platinum electrodes, when immersed into solutions of sulphuric acid, gave capacity indications of as high as ten microfarads per square centimeter of anode surface at voltages of the order of two volts. It was also soon discovered that tantalum, magnesium and aluminum showed the same characteristics.

Commercial electrolytic capacitors seem to

have found application and use as early as 1892 in connection with split phase alternating current motors, for starting purposes.

Electrolytic capacitors began to be used commercially in large quantities about ten years ago and have been used in increasing quantities ever since, until at the present time they have almost completely replaced the use of the paper dielectric type of capacitor in the fields of filter and bypass work, in the radio and allied industries. In the last three years electrolytic capacitors have also found a large field of application in connection with fractional horsepower capacitor motors for single phase alternating current.

There are two outstanding reasons why the electrolytic capacitor has replaced the paper dielectric capacitor: first, cost, and second, size. On an average, the cost of an electrolytic capacitor is one-fourth that of a corresponding paper dielectric capacitor and the size of an electrolytic capacitor is one-eighth, or less, the size of a corresponding paper dielectric capacitor. This is particularly true of capacitors rated at voltages of from 400 to 500 volts.

CHAPTER I.

Theory

FUNDAMENTALLY, an electrolytic capacitor is similar to any other type of capacitor in that it consists of two conducting surfaces separated by an insulating or dielectric medium. Likewise, the capacity of an electrolytic capacitor is determined by the same factors that

Power Output Practically Doubled

(Continued from preceding page)

the character of the program and the level at which it is applied to the input of the amplifier. Other factors remaining fixed, the greater the loss inserted at complete modulation, the shorter will be the time during which a corresponding increase will be realized at the lower program levels. Furthermore, the ratio of maximum to average peak levels of the program is reduced by the action of the amplifier, and when the volume range of the program is less than that which the transmitter can accommodate, the volume range is reduced by an amount corresponding to the loss inserted at the one hundred per cent modulation level.

Based upon the experience obtained to date, the amplifier may be lined up so that for a steady-state single-frequency tone it will insert about three db of loss at the 100 per cent modulation level without introducing any noticeable distortion or loss of fidelity in the program. Since, with this adjustment, peaks of modulation high enough to insert loss are relatively infrequent, a corresponding improvement of three db will be realized in the general program level. An improvement of this order is of course equivalent to doubling the rated carrier power of the transmitter, and is therefore decidedly worth while, particularly since it involves no change in the operating technique.

determine the capacity of any other type of capacitor. That is, the capacity varies directly in proportion to the area of the conducting surfaces, inversely in proportion to the thickness of the insulation or dielectric medium and directly in proportion to the dielectric constant of the dielectric medium.

Considerable knowledge has been accumulated on the subject of "anodic" films but the greater portion of this knowledge consists of empirical data and few actual facts are known about the fundamental theory behind the asymmetric nature of such "anodic" films.

Various schools of thought have put forth their theories, none of which, however, have been backed up with sufficient facts or evidence to remove these theories from the realm of mere probability.

From among the great number of theories put forth in explanation of the asymmetric behavior of the anodically formed film, only two theories seem to have been experimentally substantiated to any degree. These two theories are the gas film theory and the solid film theory. It may be well to point out that neither theory has been experimentally verified to fit all conditions. A consideration may also be given to the application of a combination of both theories.

THE GAS FILM THEORY

Aluminum, when made an anode in an electrolytic bath, tends to plate into solution. By electrolysis of the water, oxygen is formed and tends to collect on the surface of the anode. Aluminum, having a great affinity for oxygen, combines with the oxygen collected on the anode surface and a film of aluminum oxide is formed.

Microscopically small gas bubbles tend to remain on the anode surface and prevent complete film formation at the points where they exist. This results in a film structure of a porous nature, full of minutely small gas pockets which serve to insulate the anode surface at those points where the film does not cover over.

A reversal of polarity repels the gas bubbles and leaves the unfiled points of raw aluminum exposed to contact with the electrolyte for unimpeded conduction of current.

In other words, during the formation of the anodic film there are produced simultaneously two films: (1) an inactive film of aluminum oxide and (2) an active gas film of oxygen. The oxide film is not responsible for the asymmetric properties of the anode but seems to hold in position the oxygen gas film, which has the properties of a dielectric medium. It is considered that the pores of the oxide layer, insofar as they are not occupied by gas, are filled with electrolyte and that electrons from the aluminum can cross the gas film but that electrolytic ions from the electrolyte cannot cross.

THE SOLID FILM THEORY

The gas film theory has been held to be untenable because of some of the following advanced reasons: A gas film has a low dielectric constant and so it has been difficult to account for a sufficient lowering of the work function

to permit electron emission from a metal surface at ordinary temperatures and, furthermore, the work functions for the escape of electrolytic ions from aqueous solutions should be less than

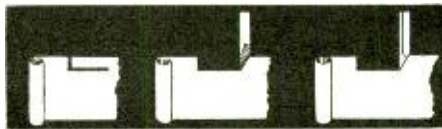

FIG. 2

The method of bringing out tabs. At left the cutting is illustrated. At center the bend is portrayed. At right is the finished tab.

in the case of electrons escaping from a metal surface.

Because of these and many other reasons it has been held that the entire anode surface is covered with a solid film of aluminum oxide or dehydration product of aluminum hydroxide. It has been stated that this film of oxide has insulating properties in consequence of the almost complete lack of free electrons, exactly as in the case of a vacuum. Electron emission from the metal anode into the insulating film of oxide is controlled by a work function as in the case of from a metal to a vacuum. As a result of the definite time required for the electrons to traverse the film from one electrode to the other, space charge effects arise and thereby reduce the current flow to a very small value. This is based on the assumption that there is a uniform distribution of the dielectric film over the entire anode surface but it is possible that the film is discontinuous and that the work function is suppressed at some points and operative at others.

Still another viewpoint of the solid film theory is one which more readily seems to fit all conditions. In this theory the anodic film is thought of as being a solid film of aluminum oxide which possesses almost infinite resistance and in which there is an almost total lack of free electrons. This film of aluminum oxide is likened to a vacuum in its function and the asymmetric nature of a polarized junction consisting of anode plate, film and electrolyte is explained by the analogy of a vacuum tube type rectifier. With the anode plate positive and the electrolyte negative, no electrolyte ions can cross the film from the electrolyte to the anode. If any electrolyte ions do cross over, the result is the formation of additional film at that point. If the polarity of the junction is reversed, electrons are discharged from the surface of the anode and a path is thus afforded for current passage through the film.

REASON FOR D-C LEAKAGE

Direct current leakage is accounted for by the fact that the film of aluminum oxide is not always complete and therefore there are always minute areas where current flow is not completely blocked.

With inactive age or shelf life the complete-

(Continued on next page)

(Continued from preceding page)

ness of the film is lessened and there are an increased number of areas where the current is allowed to pass, but when the juncture is again polarized the electrolyte ions which do pass quickly replace the breaks in the film with newly formed aluminum oxide.

Leakage current, therefore, is a function solely of completeness of film coverage and

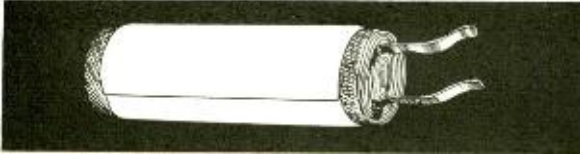

FIG. 3

The winding is completed and two tabs emerge at one end. The condenser is yet to be given a finished appearance.

film thickness. Film thickness is a function of voltage applied and therefore capacity is a direct function of voltage.

The reason that film thickness is a function of voltage is that after any film formation takes place no electrolyte ions will pass to afford additional film formation unless the voltage is increased. The passage of electrolyte ions is therefore actually dependent upon increased electrostatic pressure due to increased voltage.

By combining such a favorably polarizable junction surface with one which is not polarizable or is polarizable only in the reverse direction, an asymmetric arrangement is obtained which will possess the uni-directional current flow characteristics upon which the production of electrolytic capacitors is dependent.

CHAPTER II.

Anodic Polarization

IF the voltage of an electrode immersed in an electrolyte is altered by some cause from its equilibrium value, it is said to be polarized. It is said to be polarized anodically if it is made more positive than its equilibrium value and cathodically if it is made more negative than its equilibrium value. Such polarization may be produced by impressing an external voltage on the electrode. It may result from changes in the concentration of the electrolyte or from some interference caused by a reaction of the electrode with the electrolyte, as, for example, the formation of a non-conductive film upon the surface of the electrode.

When a metal dissolves anodically into an electrolyte, thus producing metal ions capable of combining with the ions of the electrolyte, further dissolving of the metal may be hindered as a result of the formation of a film upon the surface of the metal electrode. The presence of this film reduces the area of the electrode which is in contact with the electrolyte and as a result increases the current density upon the parts not affected. If the entire surface of the electrode is covered by such a film, the polarization must be increased to maintain a given current and as this process is followed through exceedingly high polarization may result.

The physical characteristics of the film such as its porosity, thickness, electrical conductivity

and stability may vary in different cases but it is upon the formation of poorly conductive films at the surface of a metal anode, permitting the maintenance of high voltages between the electrode and the electrolyte, and preventing the discharge of anions, and the relative stability of the anode film when made a cathode, that the production of electrolytic capacitors is made commercially possible.

The characteristic property of the "anodic" film, of poor conductivity, is only apparent when the electrode is positive in relation to the electrolyte. On reversing the polarity, the conduction of current is of course possible. In other words, the "anodic" film has an asymmetric nature.

EFFECT OF REVERSAL

Although, as has been previously mentioned, tantalum, magnesium and other metals have been used in various devices on account of possessing this asymmetric characteristic, it has remained for aluminum alone to become universally and exclusively used in the construction of electrolytic capacitors. This has been the natural result of lower cost, abundant supply and the ease of manufacture into thin foils or sheets as well as other important factors. Only aluminum will be considered as an anodic material in connection with electrolytic capacitors.

Aluminum was discovered first in 1827 and then again in 1854. Ever since the discovery of the first practical electrical method for its extraction, in 1885, aluminum was found to possess a very high affinity for oxygen and this is one of the important characteristics of the metal.

Whenever aluminum is exposed to air and moisture there is immediately formed a film of aluminum oxide. Normally this film is invisible and its thickness is of the order of molecular dimensions. Aluminum owes its stability and resistance to corrosion to this fact. Aluminum oxide Al_2O_3 occurs naturally in such forms as ruby, sapphire, corundum and emery and is extremely hard, ranking in hardness next to the diamond.

THE DIELECTRIC EFFECT

The aluminum oxide film occurring naturally, although impermeable to gases, has practically no insulating value and offers little or no resistance to the flow of current in either direction.

When, however, the oxide film is artificially produced by making the aluminum the anode in any one of various electrolytes, it takes on a definitely asymmetric character and becomes not only an insulator capable of withstanding

high voltages, but an excellent dielectric medium. Due to the fact that this dielectric has a thickness in the order of molecular dimensions, extremely large capacities can be obtained with the use of relatively small plate areas. In an electrolytic capacitor this oxide film is a dielectric medium only, however, when the aluminum plate is made the anode with respect to the electrolyte.

Very heavy or thick oxide films when washed, dried and impregnated with waxes, oils, varnishes or other insulating compounds do serve as excellent and stable insulating mediums for aluminum wires, etc. Under such conditions the films serve merely as insulation and show no asymmetric characteristics. Heat does not

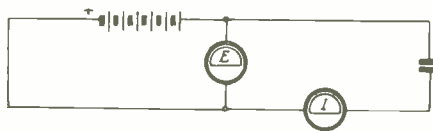

FIG. 4

The leakage is determined by using this circuit.

materially affect such films and some use has been made of such material in the form of motor and coil windings where weight is an important item of consideration.

"Radio News" Is Sold To Chicago Publishers

"Radio News" has been sold by Teck Publications, Inc., 461 Eighth Avenue, New York City, to Ziff-Davis Publishing Company, 608 South Dearborn Street, Chicago. "Amazing Stories" changed hands the same way at the same time.

Ziff-Davis publishes "Popular Photography" and "Popular Aviation." It is expected stress on illustrations will be made in "Radio News" under the new ownership, and some other policy changes adopted, beginning with the April issue.

"Radio News" was started by Hugo Gernsback. In the past decade ownership has changed hands several times.

Laurence D. Cockaday, who was editor of "Radio News," has taken a position with the Navy Department, in radio communications work. S. Gordon Taylor, managing editor, has taken on a group of consultation assignments from radio manufacturers. The advertising department is being held intact meanwhile, but only one transfer made in the editorial department.

MAE WEST BROADCAST CONDEMNED

Washington

The Federal Communications Commission condemned the broadcast of a travesty of Biblical incidents, "Garden of Eden," made on a recent Sunday night over a National Broadcasting Company network by Mae West.

Question-Answer Book Distributed by Allied

A new handbook for radio servicemen, compiled in convenient question-and-answer form, has just been published by Allied Radio Cor-

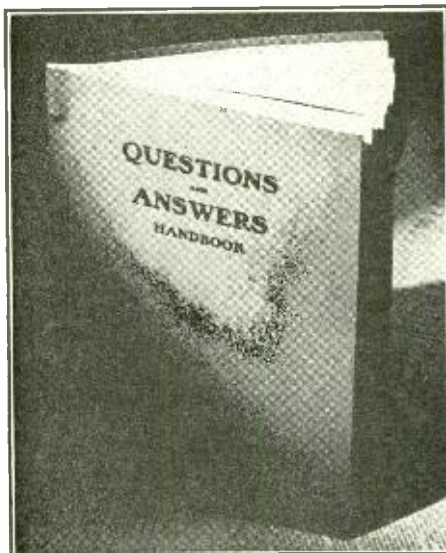

View of the book Allied is distributing.

poration, of 833 West Jackson Boulevard, Chicago. Originally planned by the Institute of Radio Servicemen, under the supervision of L. O. Gorler, the handbook offers a complete digest of essential data gathered from leading service texts, laboratories, schools, and servicemen in the field.

"Questions and Answers Handbook" includes nineteen sections, each covering a phase of radio servicing. Among the subjects discussed are: basic theory, superheterodynes, auto radio, public address, schematic diagrams and symbols, etc. Two years in preparation, the book contains more than 3,000 questions and answers, offering an authoritative and comprehensive survey of every aspect of the subject.

Published in a limited edition, the Handbook is available exclusively from Allied Radio Corporation, Chicago. The price is 95 cents.

WORLD CONVENTION IN SYDNEY

Coincident with the 150th anniversary of the foundation of Australia, a World Radio Convention will take place in Sydney, N.S.W., commencing April 4th to 14th, under the auspices of the Institution of Radio Engineers (Australia). Included among the official guests will be the Marchesa Marconi, and David Sarnoff, President of the Radio Corporation of America, accompanied by Giulio Marconi, son of the late Guglielmo Marconi, and Sir Noel Ashbridge, chief engineer of the British Broadcasting Corporation.

"President of U.S." Blasphemed, People of Nation Derided, As Sylvania Is Hoaxed in "Ad"

AN advertisement, headed "Good News," intended to promote the sale of a tube manual issued by Hygrade Sylvania Corporation, and printed in "QST," "Radio News," "Radio-Craft" and "Service," containing blasphemous reference to the President of the United States and expression of contempt for the people of the United States, caused one of the greatest furors in radio circles in a decade.

The advertisement carried an illustration at top representative of the idea of the front page of a newspaper, called Sun, and underneath the masthead was a streamer, in bold headline type, reading "GOOD NEWS." Underneath was a representation of reading matter, and it was this text that contained the slurs.

The representation of the top part of a newspaper front page, the lettering of the heading, and the small type, were hand-lettered by an artist, and appeared as part of the art layout, which underneath showed a picture of the Technical Manual, or tube book, and then followed the advertising copy setting forth in the usual manner the contents of the volume and the price. A keyed coupon appeared at bottom.

TOO LATE FOR STOPPAGE

Substantially the same advertisement was run in the four magazines, and the first that Hygrade Sylvania knew about the scurrilous contents was when an amateur, who had seen it in "QST," so informed Hygrade Sylvania. Other magazines, carrying the advertisement, already had been printed, even if not released. And though immediately notified by Hygrade Sylvania, word arrived in time for only one of them to make the denunciatory part of the advertisement illegible. That was "Radio-Craft." The offensive part of the reading matter was smudged, and thus made harmless, for part of the run.

The advertisements had been prepared for Hygrade Sylvania by Cecil Warwick & Legler, its advertising agency, and placement was made through Paul S. Ellison, advertising manager of Hygrade Sylvania, who has offices at 500 Fifth Avenue, New York City. Cecil, Warwick & Legler is one of the highest type agencies, and Mr. Ellison also enjoys a lofty reputation. Adding to these records of high standing was of course the reputation of Hygrade Sylvania itself, noted for its conservatism, and that of the magazines that printed the advertisement.

WIDESPREAD TALK

When readers who go in for inspection of very fine type read the amazing words in the

advertisement they started a buzz of incredulous conversation. Hams made no end of the topic on the air, servicemen greeted one another on the street with the question, "Have you heard the good news?" Store keepers were told about the advertisement by seemingly endless chains of visitors, who came in not so much to buy as to "chin," and mail order houses found that more letters contained reference to the advertisement than were comfortable to handle. All around there was so much conversation and even excitement that an explanation from Hygrade Sylvania was expected.

The facts were readily disclosed by Hygrade Sylvania, through Mr. Ellison, to all who inquired, pending the preparation of a statement from the president of the corporation, B. G. Erskine. Mr. Ellison said that the art work had been given to "one of the better art organizations," that when the drawing was returned no notice had been taken of the small type in which the offensive words appeared, as the drawn size of the copy was small, and the supposed reading matter was directed to be illegible anyway, and not convey any intelligence. The art organization had hired a free lance artist to do the work, and that artist had done the mischief. Mr. Ellison also explained that efforts had been made to kill the advertisement the moment that the hoax had been discovered, and the Post Office Department notified.

HAD TO WEIGH STATEMENT

Always jealous of its reputation, Hygrade Sylvania had to consider whether making a statement might not cause still further attention to be called to the obnoxious portion of the advertisement, informing persons who had not noticed that part, or had not heard of the hoax. However, so widespread was the knowledge, that the statement was made, though in the hope that the subject would soon be forgotten by the public, especially since the victimization of reputable business concerns, advertising agencies, magazines and an advertising manager was so obvious.

Since use of the mails was one of the most serious angles of the dilemma, and since the Post Office Department had been immediately notified by Hygrade Sylvania and had gotten busy investigating, the subject-matter continued to be alive, only in regard to the investigation of the artist, and the possibility of taking action against him. There were even repercussions in Washington, especially as the President of the United States had been blasphemed, and there

(Continued on next page)

Wide Scope of Interest Shown in Hoax Inquiry

Washington

Both the Post Office Department and the Attorney General's office took official interest in the situation developing out of the publication of an advertisement in some radio magazines that contained profane reference to the President of the United States, without mentioning any names, and also derided the people of the United States. However, the main activities concerning the investigations centered around New York City, in which a suspected offender lives, and around Boston, which is Federal headquarters of the district in which one of the magazines is published.

(Continued from preceding page)

was much telephoning of instructions from Washington to the New York Post Office, and exchange of information.

STATEMENT BY ERSKINE

Mr. Erskine's statement follows in full:

"A recent advertisement of the Sylvania Radio Tube Division of the Hygrade Sylvania Corporation, which appeared in a number of radio trade publications, has been the matter of much comment. Entirely without our knowledge, intent or purpose, there appeared in this advertisement, in a semi-concealed state, certain coarse and offensive phrases.

"In this advertisement there is a cut of what purports to be a newspaper containing certain body text which was supposed to be illegible and meaningless. The rough layout of this advertisement which was prepared by our advertising agency, Cecil Warwick & Legler, was turned over to the S. W. Benson Studios, a commercial art firm, for finished lettering and drawing. This art firm delegated the work to a free lance artist. As to just what happened, we can not be certain, although we have a letter from Mr. S. W. Benson, president of the art firm, in which he assumes entire responsibility for the act that was committed. The lettering, whose ever it is, is obviously the work of an unbalanced mind or the result of a perverted sense of humor.

"Every one who subsequently handled this advertisement as it went through the various stages of engraving, proving and final printing of the publications failed to note that the supposedly illegible type, when placed under a microscope, revealed the questionable material referred to.

"To our thousands of friends and acquaintances in the industry it is unthinkable that our company could have possibly had any conscious part in such a deplorable incident, and we hope that this explanation will make the whole

(Continued on next page)

QST CLEARED; SLIPUP LET IN OFFENDING AD

Boston

As "QST" was the first magazine to be published carrying an advertisement by Hygrade Sylvania Corporation containing derogatory reference to the President and the people of the United States, Federal officials co-operated in an investigation. The purpose was to fix responsibility.

The United States Secret Service took official cognizance of the situation when Chief Postal Inspector John Breslin, of this district, referred complaints to the Service. United States Attorney Robert F. Butler, at New Haven, Conn., received word from the Service about the complaints, also a copy of the January issue of "QST," and a memorandum setting forth facts as already developed.

"QST" is published at West Hartford, Conn., and is the official organ of the American Radio Relay League, all of whose members thus become subscribers by virtue of their membership. The copies being delivered largely through the mails. Also, it has a newsstand sale.

ADVERTISER SUPPLIED PLATE

Since it was learned that some artist in New York City had been responsible for drawing the illustration in which the offensive words obscurely appeared, the facts were submitted to Lamary Hardy, United States Attorney at New York City, and it is expected an effort will be made to locate the artist.

The advertisement was printed from a copper plate supplied by the advertiser.

Federal officials here were satisfied that there was no intentional offense whatever on the part of "QST," but that it had received the copper plate just before press time, and had inserted the advertisement without scrutiny of the small hand-lettered reading matter, part of which was jabberwocky anyway, and the rest of it, that could be read, and that did contain offensive material, was of such small size that, depending on one's eyesight, a magnifying glass might be necessary to permit ready legibility.

MAGAZINE EXONERATED

Another magazine, "Service," printed the advertisement in larger type, and the offending part was more readily legible, without the use of a magnifying glass. The fact that several magazines printed the advertisement was taken as conclusive proof that there was merely a slipup as to checking of the contents of the plate by the magazine. "QST," which the local investigation concerned, was exonerated.

Electrical Properties of New Bakelite Material Called "Without Rival"

A new moulding material suitable for coil forms and other radio purposes was announced by Bakelite Corporation, 247 Park Avenue, New York City. The new Bakelite plastic is known as XMS-10023. It is a polystyrene.

"The electrical properties of Bakelite polystyrene are without rival in the field of plastics," the announcement sets forth

"In the matter of power factor and dielectric constant it is superior to any other molded plastic. It provides an insulation which makes possible more efficient current transmission, or less loss of current during transmission. This makes the difference between success and failure in circuits used in ultra-short-wave radio frequencies and television. In a field of thirty million cycles such as is used in these circuits, it is the only plastic that is satisfactory. In fact, it is one of a very few plastics which does not actually disintegrate by the stresses set up under such frequencies. XMS-10023 possesses a loss factor of less than .00053, a power factor of less than .0002.

"Its dielectric strength is excelled by few plastics. This means that a thinner wall of this material can be used to protect the conductors and prevent the electric current from arcing through. This, and its low specific gravity (or weight per unit volume) make possible lighter and less bulky insulation. Its dielectric strength is more than 500 volts per mil; its resistivity 10^8 megohm-centimeters; and its arc resistance 240-250 seconds (proposed A.S.T.M. Method).

"The water absorption of Bakelite polystyrene is an extremely important feature. Many insulators are excellent as long as they are kept free of water, but are useless when exposed to moisture. The absorption of XMS-10023 is only 0.05% on a $2\frac{1}{2}$ " disc, after 318 hours total immersion. To illustrate the significance of this fact, insulation of this material is still more efficient after 100 hours' immersion than general purpose Bakelite molded insulation ready for installation."

(Continued from preceding page)

situation clear in the mind of any one whom it reaches.

"The matter has already been called to the attention of the Inspector in charge of the General Post Office in New York City, who now has all the circumstances under investigation.

"We realize, in making this statement, that we may be bringing the matter to the attention of many who otherwise would not have been advised of it, however, we feel that complete candidness is called for and we feel confident that our good faith will be unquestioned and our good-will unimpaired.

"HYGRADE SYLVANIA CORPORATION"

"B. G. ERSKINE,
"President"

Literature Wanted

Readers whose names and addresses are printed herewith desire trade literature on parts and apparatus for use in radio construction. Readers desiring their names and addresses listed should send their request on postcard or in letter to Literature Editor, Radio World, 145 West Forty-fifth Street, New York, N. Y.

- W. B. Schagerstrom, 1509 E. 70th St., Chicago, Ill.
 John Weare, 22 Farrar St., Cambridge, Mass.
 John Strachanowski, Stab Pl. 32, Schwedt, Oder, Germany.
 John J. O'Lalor, 16 Kenwood St., Brookline, Mass.
 A. V. Morrison, R. F. D. Yuba, Wiske.
 Alan R. Meggett, 1633 West 55th St., Los Angeles, Calif.
 A. J. Bewsher, 8 High St., Burne, Tas.
 Dana Heckart, Sisseton, So. Dak. On S. W. Receivers, Xomitters, parts and experimental apparatus.
 Thomas Roberts, Jr., Consumers' Research, Inc., Washington, N. J.
 Bernard Mayer, Eastern Radio Service, 116 Cottage Rd., Sydney, N. S., Canada.
 Wm. J. Clarke, Radio Service Man, 1234 High St., Malvern, S. E. 4, Victoria, Australia. Radio and radio parts and electrical equipment.
 Ulysses D. Bryant, Stonega, Virginia.
 James N. Henderson, 674 King St., E., Hamilton, Ont., Canada.
 Louis Della-Rocco, 1101 Magee St., Elmira, N. Y.
 Hartman Van Deventer, Radio Service, Box 358, Sioux Lookout, Ont., Canada. Service equipment and radio parts.
 Arthur Grishaber, 137 So. Walter Ave., Appleton, Wis.
 Arthur Faas, 1016 W. 31st St., Chicago, Ill.
 A. G. Lee, Box 22, Cornwall, N. Y.
 Daniel Thaler, 940 57th St., Brooklyn, N. Y.
 L. J. Meyers, Meyers Service Shop, 415 Mill St., Ironton, Ohio.
 Paul H. Gintler, New Holland, Ill.
 M. Bauer, 600 West 175th St., New York, N. Y.
 Leslie Gilliland, Box 205, Pinehurst, N. C.
 T. M. Spiers, 20117 Santa Rosa Drive, Detroit, Mich.
 J. Lee Cooke, 1213 Prince Edward St., Fredericksburg, Pa.
 Orville Wogen, Emmons, Minn.
 M. D. Post, 1012 University, Boulder, Colo.
 C. Joseph Johnson, 3445 Evaline Ave., Hamtramck, Mich.
 J. Robert Eshbach, Hershey Ind. School, R. F. D. No. 2, Unit 20, Hummelstown, Pa.
 F. F. Feiner, 3673 Lafayette Ave., St. Louis, Mo.
 John Robert Novak, 2305 E. Ann St., Philadelphia, Pa.
 Arthur Ross, 1010 3rd St., E., Calgary, Alta., Canada.
 I. Otto, 269 W. 12th St., New York, N. Y.
 R. J. Rabour, 9 West Bowers St., Lowell, Mass.
 Foster Porter, Porter's Radio Shop, Martin, Ky.
 Morris Davidson, Pres., Sunset-DX-Club, 1445 So. Millard Ave., Chicago, Ill.
 Geo. Solkover, 2712 East Fir St., Seattle, Wash.
 Arthur Renaud, Sturgeon Falls, Ont., Canada.
 Lawrence E. Cromwell, 2411 S. E. 40th Ave., Portland, Ore.

PARTS SHOW IN JUNE

The National Radio Parts Trade Show will be held at Chicago next June. The Exhibition Hall in the Stevens Hotel, where the parts show will be held June 8-11, inclusive, will be laid out as a city, to be known as Radio Parts City. Each street, avenue, and boulevard will be named in honor of a deceased outstanding figure in the development of radio, such as Marconi, Ampere, Edison, etc.

TYPE AND VIEWS SENT NIGHTLY IN WSM FACSIMILE

WSM, Nashville, Tenn., is experimenting with facsimile transmission, so that printed matter and pictures can be received and recorded at home.

Facsimile is a means of transmitting these over the regular broadcasting channels, half-tone reproductions being included. When facsimile is sent, program sound is not.

An attachment on the regular radio set receives the pictures and words on a roll of paper two columns wide.

The principle does not vary greatly from that of wired photo, used by newspapers.

Copy to be sent over the air is inserted in a scanning machine. Then light from a small electric bulb is focused as a tiny spot on the copy. By means of the photoelectric cell the light is converted into an electrical tone signal varying in loudness to correspond to black, white, or halftones of the copy. The scanning machine takes the place of the microphone and is connected with regular broadcast equipment in much the same manner. Facsimile signals are transmitted over the air just as in regular sound broadcasting, using normal power and assigned broadcasting frequencies.

MIDNIGHT TO 6 A.M.

WSM will transmit facsimilies on its regular 650 kc frequency and with its regular 50,000 watts.

At midnight the powerful Nashville station will cease broadcasting for the ear and begin its broadcasting for the eye. The present experimental permit allows transmission of facsimile from midnight, Central Standard Time, to 6 A. M.

As copy is sent through the transmitting machines at the WSM studios, the receiving set attached to radios in American homes reproduces that copy instantly.

At any hour, the receiving set can be tuned to WSM, the hour set for midnight, and then automatically at that hour the facsimile receiving set will begin to reproduce whatever WSM sends through the new medium.

"AN UNKNOWN QUANTITY"

Upon arising the next morning, one has only to go to the receiving set and there find six hours of broadcast-transmission rolled out of the machine in two-column widths.

Harry Stone, general manager of WSM, ex-

Cornell-Dubilier Enhances Safety at High Voltages

An advance toward increased safety in operation of high-voltage power supplies is credited to the Cornell-Dubilier Electric Corporation. Recently this capacitor manufacturer came out

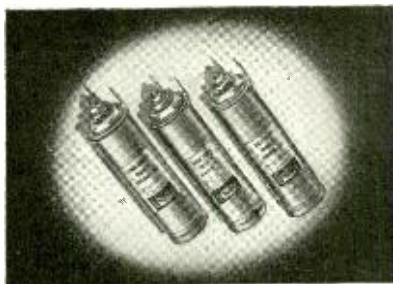

The optional mounting facility is featured.

with a universal mounting bracket, supplied at no extra cost with each high-voltage filter capacitor, which permits either upright or inverted mounting.

Radio amateurs and other users of high-voltage power supplies will welcome this mechanical improvement applied to the C-D type TJ-U line of dykanol filter capacitors. The idea behind this innovation is to minimize the risk of accidental "shocking" by considering safety as part of the power supply's construction, rather than the exercising of caution during the apparatus' operation. By easily mounting high voltage filter condensers in an inverted position so that high voltage terminals are under the chassis, safety to the operator is enhanced.

plains that the undertaking is entirely experimental in nature.

"Facsimile is still an unknown quantity," Stone declared, "And WSM is merely pioneering in an endeavor to determine what its values and potentialities may be. We expect it to be of greatest values to rural areas in America."

Stone explained that WSM was footing the entire bill. In addition to the transmitting machine, WSM has purchased 50 receiving sets, which will be set up in lighthouses, schools etc. in remote areas, and families ranging in distance from Nashville from 10 to 1,000 miles.

WSM engineers hope to determine what effect static and adverse weather conditions may have on facsimile, determine the difference between ground waves and sky waves (which may cause reproduction of two pictures instead of one on long-distance transmissions) and also determine the feasibility of long distance transmission of facsimile.

GERMAN TUBE FOR TELEVISION 25 INCHES WIDE

A resume of developments in radio during 1937, mainly outside the United States, has been released by International Telephone and Telegraph Corporation, through Frank C. Page, vice-president. The part dealing with television follows:

In the field of television the year brought forth no startling changes. Progress, however, has been consistent.

The British Broadcasting Corporation standardized on the Marconi E.M.I. system and has ceased transmission with the Baird system. Program time is now three hours daily, a large part of the program being direct vision by means of the Emithron camera.

Some fourteen manufacturers showed television receivers at the recent exhibition at Olympia (London). The prices ranged from £38 to £125.

In France the old television equipment has been entirely replaced by modern studio and

transmitter equipment, capable of giving 455 lines. Direct or film signals are used with the pick-up located either at the P.T.T. studio or at the Radio Palace at the Paris Exhibition. A vision transmitter of 30 kw peak power, supplied by Le Materiel Telephonique, Paris, has been installed at the base of the Eiffel Tower and has been connected to the antenna at the top by a concentric cable. The vision transmitter operates on 46 megacycles and the sound transmitter on 42 megacycles.

25-INCH GERMAN TUBE

In Germany the Berlin 15 kw transmitter has been sending a 180 line picture, but it is planned to change to 441 line interlaced transmission using positive modulation, only the d-c component being transmitted. Three new transmitters are reported to be planned: one on the Broechen, the highest point on the Hartz mountains; one on a peak near Frankfort, and one near Berlin. Work on the first is understood to be well advanced. Receivers with cathode ray tubes 25 inches in diameter are used, the 14 inches by 16 inches images produced being reported as brighter than ordinary moving pictures.

E. I. A. R. (Italian Broadcasting Co.) are understood to be considering the installation of a 30 kw peak vision transmitter in Rome. It has been stated that Russia has placed an order for a complete studio system and transmitter with R.C.A.

There has been an advance in the intermediate

(Continued on next page)



Television tubes as generally used in this country by the leading developers are about one foot in diameter, as, for example, the tube Philco uses in its experiments, shown in process of manufacture. The new German tube has more than twice that diameter.

Technical and Program Problems Being Solved As Television Advances

By **LENOX R. LOHR**

*President,
National Broadcasting Company*

In television we have begun to accumulate operating experience against the day when this art becomes a commercial actuality. In addition to the technical progress of television during 1937, we have, in conjunction with the Radio Corporation of America, contributed towards the solution of program problems through the constant use of an experimental television studio.

More than 60 television demonstrations have been given by NBC in the past year; nearly 300 persons have appeared before our television cameras; full-length drama has been presented, using five different studio sets, and film taken especially for the production. Experiments with educational program material, and with the color response of facial make-up and costume fabric, also have been undertaken. A most recent development is America's first mobile television station, the RCA-NBC Telemobile transmitter, to be used during the coming year for experimental televising of outdoor news events.

(Continued from preceding page)

film pick-up by Fernseh A.G. By means of a special process, a film scanner has been produced which photographs, develops and transmits the picture within 16 seconds of the action.

DEPEND ON COAXIAL CABLES

The new N.B.C., Washington, D. C., studios, opened in 1937, include television equipment. Extensive provision has been made for visual broadcasts.

Wide publicity is given periodically in the popular press to television programs being received at great distances. Such reception, however, as is well known to technicians, is of a distinctly freak nature, the range covered reliably being of the order of 30 miles. Since television programs are expensive, it seems obvious that television for some time to come at least will be dependent on coaxial cables for distribution purposes.

JETT, CHIEF ENGINEER OF FCC

Washington

Ewell K. Jett, assistant chief engineer of the Federal Communications Commission, and retired Navy lieutenant, was appointed Chief Engineer of the Commission to succeed Commissioner T. A. M. Craven.

G.E. WILL SEND FAR EAST BEAM FROM NEW SITE

Washington

Permission has been granted the General Electric Company to erect the first international broadcast short-wave radio transmitter west of the Mississippi River, to be located at Belmont, Calif., and construction will be started immediately. Two short-wave frequencies now assigned to the Company—9,530 kc = 31.48 meters, and 15,330 kc = 19.56 meters—will be used.

The station will be equipped with directional antennas, with beams directed to the Far East and South America. These beams, concentrating the transmitter output of 20 kilowatts within an angle of about 30 degrees, will provide a signal gain of about 300 per cent over the ordinary antenna.

In order to serve the Far East, at present radio signals following a great circle path from the existing international broadcast stations located only in the eastern part of the United States must pass directly over the north polar regions.

HOPE TO END "SPOTTINESS"

The magnetic field of the earth and the daylight-darkness distribution over this path are subject to extreme variations, and their effect on radio signals is believed to be the cause of the failure of radio transmissions to the Orient and has prevented reliable broadcast service from the United States. Such service as can now be rendered from Schenectady to the Far East is "spotty," varies from season to season and from hour to hour, and to a large extent is unavailable during the evening hours of the Orient.

On the other hand, the great circle path from the proposed location in Belmont does not pass over the north polar regions, is a more east-west path, and therefore should not be subject to the extreme variations found in the signals transmitted from Schenectady, New York.

DAY AND NIGHT SERVICE

The programs of this station will consist of features now offered by the red and blue networks of the National Broadcasting Company, as well as many programs designed especially for short wave.

The 9,530 kc frequency will be used when the path between the transmitter and listening points are entirely dark, while the 15,330 kc frequency channel is most useful when the path is part light and part dark.

RADIO CONSTRUCTION UNIVERSITY

Answers to Questions on the Building and Servicing
of Radio and Allied Devices.

CAPACITY MEASUREMENT

AS I possess a good a-c voltmeter, will you please reveal some simple method whereby I may make measurements of capacities?—R. E. C.

The diagram for application of the method

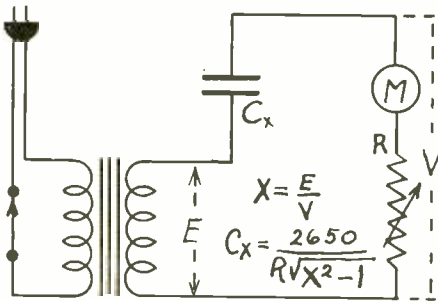

A method of measuring capacity, using an a-c voltmeter and a transformer. The object of the transformer is to bring the reading of E volts readily within the scale of the a-c voltmeter.

is shown herewith. C_x is the condenser the capacity of which is to be determined, hence is the unknown. The ratio X is represented by two readings taken on the voltmeter, M . The first reading is E , with the condenser C_x omitted, and the second, V , with the condenser included. The smaller the ratio the higher the capacity, for when the capacity is infinite, the ratio is unity. R is the resistance of the voltmeter, which is known, or can be ascertained from the meter manufacturer, or usually appears in his catalogue. The arrow through the resistance R merely denotes the resistance of the meter may be increased by external multipliers or otherwise.

* * *

HUM IN A MIDGET

WHAT can be done to reduce hum in a midget receiver? Mine is so small it fits on a night table in the bedroom. The trouble developed only recently.—L. K.

The trouble is likely due to an electrolytic condenser. Electrically remove one such condenser and replace with another of equal or greater capacity, taking care to observe proper polarity. See if the hum is greatly reduced. If not, restore the connection as it was—since the "removal" consists merely of opening posi-

tive lead of the condenser, and restoration closing the lead again. If hum is now greatly reduced, the troublesome condenser has been identified, and the new one is used as permanent replacement. It may be that two new condensers are required, and this test will be made with two condensers. It is often preferable to use much larger capacity than was in the receiver originally, not next to the rectifier, but after the choke, i.e., B plus feed of receiver to ground or B minus. This would be true for those persons fussy about hum, as the small sets are economically made, and the user may prefer better filtration.

* * *

MEASURING DECIBELS

SINCE I have a meter that works on a.c. and is substantially nonreactive, at least for audio frequencies, and draws very little current, so that loading effect on an output transformer is negligible, please let me know some method whereby I may make determinations in decibels.—I. G. C.

Where there is negligible power dissipated in the measuring circuit it is permissible to put 500 ohms across the input to the a-c meter, assuming there is no d-c continuity at this meter input, and use 1.73 volts as the zero level. See curve on page 59. This is equivalent to .006 watt, 6 milliwatts. Since decibels reflect gains and losses they are independent of any particular power level, but for establishment of a standard some particular power level is necessary, and in radio practice this is .006 watt. It is the power output at which receiver sensitivity is measured, also. It is advisable to disconnect speaker voice coil, connect primary of an additional output transformer in parallel with primary of the coil in the receiver, and secondary of the extra output transformer to the meter, which has the 500 ohms across it. For most accurate results the transformer turns ratio should equal the square root of the ratio, plate impedance of output tube divided by 500, i.e., $\frac{\text{primary}}{\text{secondary}} \text{ ratio equals } \sqrt{R_p \div 500}$. The smaller winding is the secondary. The ratios for power tubes lie between 2:1 and 3:1. The plate impedance is read from tube manuals.

* * *

RECEIVER ALIGNMENT

WHAT do you suggest as the best method of alignment of a receiver of very high-

grade type? I desire to attain as nearly as possible perfect tracking, and while I am familiar with the padding method, I am not so clear about checking on the padding.—K. R. D.
 Considering only the standard broadcast

band, for presentation of the theory, since the manipulation is in general the same for other bands, the i-f channel is aligned, then the local oscillator parallel trimmer is set for the fre-
 (Continued on next page)

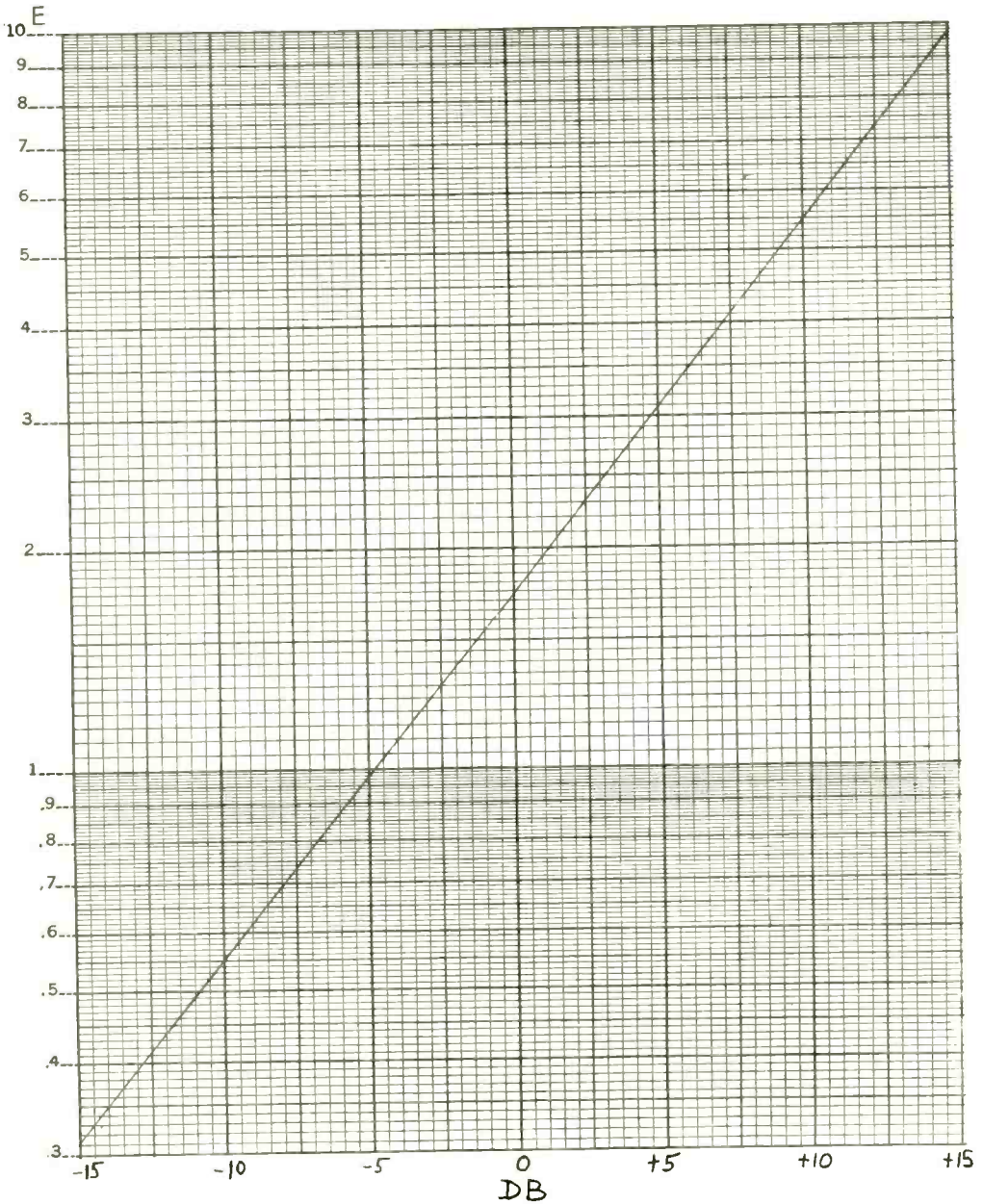

If a 10-volt scale is used on an a-c voltmeter, and a 500 ohm resistance is put across the input of meter, which must not have d-c continuity with the 500 ohms, the voltages E as read at left upright will correspond to decibels up and down from 1.73 volt zero db level, which is equivalent .006 watt, the radio standard zero level. For instance, 3 volts equals + 4.75 db.

(Continued from preceding page)

quency recommended by the manufacturer (1,450 or 1,500 kc, usually), so as to agree with the frequency imprinted on the dial. Thus the dial is turned until the desired frequency is read, and the adjustment is made. Next the parallel trimmers on the r-f sections are adjusted for maximum output. It is assumed small output of a signal generator is used. Next the dial is turned to give the frequency reading of the other tiedown point (usually 600 kc), and the series padding condenser in the oscillator is adjusted for maximum output. This particular act at this end is just an approximation. It is now necessary to "rock" the condenser, meanwhile adjusting the series padder bit by bit, to ascertain in which turning direction, if any, the output is increased, and the settings of padder and dial are compromised so that there is optimum output. The dial reading in frequency now may be somewhat different from true frequency, but this difference is ignored, as the object is to track the set as nearly perfectly as possible, not with the dial, but oscillator to r.f., in other words, so that the same intermediate frequency is always generated. Now with signal generator very weakly coupled to the second detector, even perhaps by just laying a wire from the generator near the second detector tube, or some "hot" lead to that tube, register a beat, so a sound is heard, with receiver dial at either tiedown point. Make this any audio frequency you like. Now as you turn the receiver dial, if tracking is perfect, the frequency of this beat will remain the same. If there is departure from tracking, the frequency of the beat will denote this. In fact, the difference in frequency of the beat, between either tiedown point, and other points, will give the frequency of the deviation from perfection. It is considered good work to keep the difference to not more than 5 kc (5,000 cycles). A point to watch is that if a beat change appears at about 1,000 kc, the oscillator inductance may be "off," and if that inductance is too low, an experimental increase may be made by raising the shield that surrounds the coil, until the beat is the same as it was at the selected tiedown point. Now the tiedowns have to be repeated, because of the inductance change. When these two former operations are renewed, and the check is remade at 1,000 kc, and the beat is what it should be, the tracking has been improved by a third tiedown point, due to inductance, at midband, and the oscillator coil is then made permanently proper, by addition of secondary turns, and full shielding restored. A fact to bear in mind is that there may be second harmonic current in the intermediate amplifier, so that an otherwise unaccountable response arises from twice the intermediate frequency. For instance, for 455 kc i. f. this response would arise from 910 kc, which was one reason for selecting midway 1,000 kc for test. Leakage from the signal generator may supply current to the r.f. at this harmonic frequency. For true tracking this beat will be zero, but various disturbances usually result in some sort of gurgling sound, for instance, difference in the

rate of change is one sound producer. It is well to know about this second harmonic and not mistake it when checking tracking by the i-f beat method just outlined.

* * *

TUBES AS OSCILLATORS

THE grid leak type oscillators are really automatic-volume controlled, and since this is true, is it not advantageous to use tubes that have remote cutoff characteristics, rather than tubes with high transconductance?—U. D. V.

For purposes of frequency stability, and minimization of harmonics, it is well to use remote cutoff tubes, and particularly such tubes as provide minimum frequency change with bias alteration. Such a tube, for instance, is the 6J8G, a multigrid mixer. The heptode section (modulator) may be used as r-f oscillator, and with 50,000 ohm grid leak, grid current maintained at least 30 microamperes. The usual oscillator section as used in receivers, here may be employed instead as audio oscillator, for modulation, and there will be electronic coupling of the two frequencies. However, in considering the r-f oscillator, the greatest output is obtained from tubes having the greatest conductance, hence the 6J5G, having a much higher conductance, would be preferred if quantity of output is significant.

* * *

PERCENTAGE MODULATION

IS it correct to say that percentage modulation is the ratio of the modulated carrier to the unmodulated carrier voltage?—E. L. C.

No. It is not the ratio of the one voltage to the other that is at stake, but the ratio of the difference between the two, to one of them, i.e., effective percentage $M\% = (100 \times d) \div E_c$, where d is the difference and E_c is the average carrier amplitude. A single tone is considered.

* * *

DAMPED WAVES

ARE damped waves the same as amplitude modulated radio-frequency waves?—I. F. D.

No. Damped waves are waves of which the amplitude of successive cycles, at the source, progressively diminishes. Thus the average value of the carrier diminishes. Amplitude modulation of a radio-frequency carrier leaves the carrier average unchanged.

* * *

MEASURING INDUCTANCE

SINCE I have a general-purpose meter that reads volts, currents, etc., including capacity in microfarads, I was wondering if there is some simple calculation I can perform to convert the capacity readings to henries, using the same 60-cycle line current?—K. C. D.

Yes. There are 7.03 henries for each microfarad, or, closely enough for your purposes, 7. However, the capacity reactance decreases with increase of capacity, whereas the inductive reactance increases with increase of inductance. Frequency assumed constant in both instances. Therefore divide the capacity reading in micro-

farads, into the number 7. Thus for .5 mfd. the inductance reading would be $7 \div .5 = 14$ henries. For 1 mfd. the inductance would be 7 henries. For 2 mfd. it would be 3.5 henries, etc. Since the capacity scale may read high capacities rather than small ones, it will read low inductances rather than high ones. For instance, compare 7 henries (1 mfd.) with 70 henries (.1 mfd.). It should be remembered that the inductance depends also on the d.c. flowing through the unknown coil. It is therefore better practice to use 4.5 volts (three No. 6 dry cells in series) and a series resistor so that the rated d.c. will be sent through the coil when the measurement is made. If the resistance of the coil is measured, the extra resistance is included to supply the right current. For instance, resistance in ohms equals voltage in volts divided by current in amperes. If the battery is taken as 4.5 volts, then for a current of 100 milliamperes the total resistance required is 45 ohms. If the coil has less than 45 ohms resistance, then the difference is supplied.

* * *

USE OF 6J8G

PLEASE state whether the 6J8G converter tube may be used as replacement of the 6A8G, also what are the chief advantages of the new tube?—E.L.V.

This tube combines a triode oscillator element with a heptode converter section, so designed as to avoid oscillator frequency drift with change in applied a-v-c voltages. Although the basing arrangement of this tube is such that it may in some applications be substituted for type 6A8G with slight realigning, it is not primarily intended for use in this manner. As compared with 6A8G, the reduction of some of the interelectrode capacities is an important advantage in type 6J8G. High conversion gain is maintained at frequencies of 18 mc and above, and the ratio of signal to noise is materially improved, says Sylvania. The exceptionally high plate resistance of 4.5 meg. makes it pos-

sible to use a high quality i-f transformer with marked advantage in gain. The selectivity of a high Q tuned circuit is not appreciably impaired by shunting the plate resistance of this tube across it. High input impedance is maintained under all normal operating conditions. Type 6J8G provides true electron coupling since the grid of the triode oscillator is directly connected to an injector grid in the mixer section.

6J8G CHARACTERISTICS

Heater Voltage AC or DC..	6.3 Volts
Heater Current	0.3 Ampere
<i>Operating Conditions and Characteristics</i>	
Heater Voltage	6.3 Volts
Plate Voltage (Heptode)...	250 Volts Max.
Control Grid Voltage	
(Heptode)	-3 Volts
Screen Voltage (Heptode) ..	100 Volts Max.
Oscillator Plate Voltage	
(Triode)*	250 Volts Max.
Oscillator Grid Resistor	
(Triode)	50,000 Ohms
Plate Current (Heptode)...	1.2 Ma.
Screen Current (Heptode) ..	2.8 Ma.
Oscillator Plate Current	
(Triode)	5.0 Ma.
Oscillator Grid Current	
(Triode)	0.4 Ma.
Plate Resistance (Heptode).	4.0 Megohms
	Approx.
Conversion Conductance ...	290 μ mhos
Control Grid Voltage (Heptode)	
for 2 μ mhos Conversion	
Conductance	-20 Volts
*Applied through 20,000 ohm dropping resistor	

The base connections, RMA standard, are: 1—no connection; 2—heater; 3—heptode plate; 4—heptode screen; 5—triode (oscillator) control grid; 6—triode plate; 7—heater; 8—cathode; cap—heptode control grid. Suppressor is tied to the screen internally, and oscillator grid is internally common to a screen suppressor.

RMA Seeks to Lift Tax on Sets Sold Under \$50

Washington

Some reduction in the federal 5 percent excise tax on radio and phonograph apparatus is being asked by Radio Manufacturers Association, Inc. The entire radio manufacturing industry and trade, including distributors and dealers, are being enlisted.

That at least "the poor man's" radio should be given tax exemption has been emphasized in discussions in Washington. A tentative proposal was made for tax exemption of radio sets sold for less than \$50, covering the low and medium price range of the ordinary and general purchaser, reduction of prices to millions of radio purchasers, together with increased sales and increased employment in the radio industry, would result, it was argued.

Allied Makes a Hit With Its 3-day Show

Thousands of radio dealers, servicemen, and amateurs packed the salesrooms of Allied Radio Corporation in Chicago during the "1938 Chicagoland Radio Show" held recently. The three-day schedule included demonstrations of new radio equipment, talks by radio experts, and exhibits and previews by leading manufacturers.

Hit of the show was the opening of Allied's new recording studio with recording throughout each day. Other popular features were the radio receiver preview in which 1938 electric push-button tuning models were demonstrated; a model service shop in operation; a "questions and answers" booth headed by L. O. Gorder; and an amateur exhibit featuring 5-meter transmission and reception.

ANOTHER POLL GIVES THE LEAD TO JACK BENNY

"Fortune" has made a survey of listener likes and has tabulated the results in percentages as follows:

<i>Favorite Program</i>	<i>Favorite Personality</i>
Jell-O (Jack Benny) 8.7%	Jack Benny..... 10.7%
Major Bowes..... 6.9	Boake Carter..... 7.1
News broadcasts... 6.6	Lowell Thomas.... 5.9
Chase & Sanborn	Eddie Cantor..... 5.5
(Charlie McCarthy) 5.8	Bing Crosby..... 5.4
Ford Sunday Evening Hour..... 4.3	Major Bowes..... 4.6
One Man's Family. 4.2	Bob Burns..... 4.3
Lux Theatre..... 3.5	Nelson Eddy..... 4.0
Kraft Music Hall... 3.3	Edwin C. Hill.... 3.5
Amos 'n' Andy.... 3.0	Charlie McCarthy.. 3.0
Gang Busters..... 2.5	President Roosevelt 2.7
Fibber McGee and Molly 2.4	Gracie Allen..... 1.9
Lum and Abner.... 2.3	Fred Allen..... 1.4
Texaco	Edgar Bergen..... 1.3
(Eddie Cantor).. 1.9	Lum and Abner... 1.0
Lucky Strike Hit Parade 1.8	Rudy Vallee..... .9
All others 42.8	All others..... 36.8

BENNY STEADILY FIRST

The magazine comments as follows:

"Jack Benny of the Jell-O program, for four years voted the outstanding comedian of the radio in a newspaper poll, apparently deserves this distinction again in the public estimation. After him follows a strange medley of preferences, a mixture of news comment and classical music, amateur entertainers and bucolic humor, popular music and crime, with President Roosevelt nosing in between a ventriloquist's dummy and the infantile Gracie Allen.

"Particularly to be noted is the fact that while reading newspapers is the favorite pastime of 7.1 per cent of the population, news broadcasts elbow their way to third place among a multitude of programs that are designed for pure entertainment value, and Commentators Boake Carter, Lowell Thomas, and Edwin C. Hill have a collective personal following of 16.5 per cent of the listeners.

"In the Northeast Lowell Thomas and Boake Carter actually rank in first and second places with Jack Benny third—in spite of the fact that the daily press in this section probably reports world news better and more abundantly than elsewhere.

ECONOMIC COMPARISONS

"This has significant bearing upon journalism, for it seems to mean that world news edited by the town criers of the air has a much readier acceptance than news in cold print. Conceiv-

Poll of Editors Also Puts Jack Benny Out Front

A nation-wide poll of radio editors and critics, conducted by "Radio Daily," produced this result, the figures representing points out of a possible 980:

PROGRAMS	
Chase and Sanborn.....	482
Jell-O	440
Royal Gelatin	296
Kraft Music Hall	287
Town Hall Tonight.....	260
Lux Radio Theater.....	188
N. Y. Philharmonic.....	185
Chesterfield	136
Ford Sunday Evening Hour.....	124
Magic Key of RCA.....	103

PERSONALITIES

Jack Benny	508
Edgar Bergen-Charlie McCarthy.....	491
Fred Allen	361
Bing Crosby	355
Nelson Eddy	138
George Burns-Gracie Allen.....	144
Rudy Vallee.....	126
Kate Smith } (Tie).....	111
Bob Burns }	111
Jeanette MacDonald	108

ORCHESTRAS

Guy Lombardo	387
Wayne King	292
Benny Goodman	285
Andre Kostelanetz	242
Hal Kemp	187
Tommy Dorsey	160
Horace Heidt	143
Paul Whiteman	127
Shep Fields	105
Raymond Paige	94

NEWS COMMENTATORS

Edwin C. Hill.....	432
Boake Carter	412
Lowell Thomas	326
H. V. Kaltenborn.....	226
Paul Sullivan	148

SPORTS COMMENTATORS

Ted Husing	670
Clem McCarthy	259
Bill Stern	156
Bill Slater	108
Red Barber } (Tie).....	61
Graham McNamee }	61

ably the freedom of the press may come to be an issue more academic than real.

"By economic levels Boake Carter is tops with the prosperous, Jack Benny with the middle classes and the poor, and Major Bowes with the Negroes. And the reason for this, of course, is that many a colored man pictures himself as the glorified amateur tap dancer performing before the Major's microphone."

The magazine points out that the amount of time programs are on the air and the hours at which they are heard necessarily affect their listenership—especially among the many people who simply like "to play the radio."

Now—a high powered

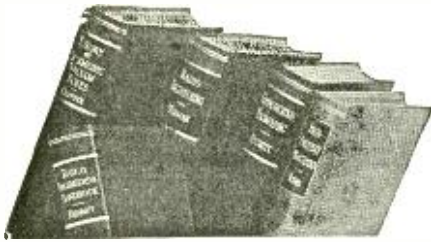

Radio Engineering Library

—especially selected by radio specialists of McGraw-Hill publications

—to give most complete, dependable coverage of facts needed by all whose fields are grounded on radio fundamentals

—available at a special price and terms.

These books cover circuit phenomena, tube theory, networks, measurements, and other subjects—give specialized treatment of all fields of practical design and application. They are books of recognized position in the literature—books you will refer to and be referred to often. If you are practical designer, researcher or engineer in any field based on radio, you want these books for the help they give in hundreds of problems throughout the whole field of radio engineering.

5 volumes. 2891 pages, 2000 illustrations

1. Everitt's COMMUNICATION ENGINEERING
2. Terman's RADIO ENGINEERING
3. Chaffee's THEORY OF THERMIONIC VACUUM TUBES
4. Hund's HIGH-FREQUENCY MEASUREMENTS
5. Henney's RADIO ENGINEERING HANDBOOK

10 days' examination. Special price. Monthly payments \$26.00 worth of books cost you only \$23.50 under this offer. Add these standard works to your library now; pay small monthly installments, while you use the books.

SEND THIS ON-APPROVAL COUPON

RADIO WORLD,
145 West 45th St., N. Y. City.

Send me Radio Engineering library, 5 vols., for 10 days' examination on approval. In 10 days I will send \$3.50, plus few cents postage, and \$3.00 monthly till \$23.50 is paid, or return books postpaid. (We pay postage on orders accompanied by remittance of first installment.)

Name

Address

City and State

Position

Company R.W. 1-38

ALLIED offers RADIO'S GREATEST VALUES

AMATEUR GEAR!

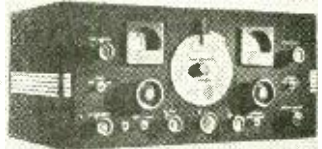

SOUND EQUIPMENT!

OVER 12,000 PARTS!

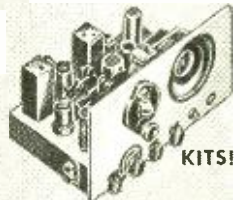

KITS!



TEST EQUIPMENT!

EVERYTHING IN RADIO AT LOWEST PRICES

For Dealers - Service Men
Sound Men - Amateurs - Set Builders

ALLIED's big 164 page Catalog brings you everything in radio in one great book, at lowest prices: Over 12,000 parts for building or repairing any circuit; dozens of Build-Your-Own Kits, from beginner's one-tube to 14-tube all-wave superhet; complete amateur gear—transmitters, receivers, transceivers—all leading lines; 61 New KNIGHT Radios, featuring Push-Button Tuning at lowest prices; Sound Systems for every P. A. need; test equipment, books, tools, etc. Every radio requirement at your finger-tips for instant selection! ALLIED's complete stocks and fast service save you time—ALLIED's low prices save your money! Send coupon today for ALLIED's free 1938 Catalog—radio's complete supply guide!

Write for FREE PARTS LISTS for any Kit shown in any radio publication.



FREE

ALLIED RADIO CORP.
Dept. 16-B-8, 833 W. Jackson Blvd.
Chicago, Ill.

Send your Free 1938 Catalog.

Name

Address

City..... State.....

A Life's Savings is Protected by a Will



A Booklet of Standard Last Wills and Testaments with extra clauses so that in secret without other legal advice a perfectly legal non-breakable Will can be made by simply copying Will desired and only filling in your names in the legal blank form Will which we send you with booklet of full instruction complete for One Dollar.

Money Back if not satisfied.

Address Dept. FC-38, Radio World, 145 West 45th St., New York City.

You need . . . these **2** books

RADIO SERVICING SHORT-CUTS and Money Making Ideas

A completely new and different book tells how radios may be repaired quickly with the absolute minimum of test equipment. Proves that by an actual test 9 out of 10 radios can be fixed with simple tools and volt-ohmmeter. The author, M. N. Beitman, for years in the servicing profession, realized and kept data on these facts. Page after page of practical information. Many real money-making ideas and hints applicable to all sets. (Size: 8½ x 11 in.)

PUBLIC ADDRESS SYSTEMS

A practical handbook, full of useful information, fully illustrated. Considers in detail various microphones, radio and phonograph inputs, acoustic feed-back, mixing and volume controls, use of vacuum tubes, interstage coupling, power amplifiers, output coupling, loud speaker placement, the decibel, P.A. measurements, power level, and other points of importance, including actual circuit diagrams of tested P.A. systems.

Price, 50c each book.

SUPREME PUBLICATIONS

3727 West 13th St., Chicago, Illinois

CHASSIS-CABINETS PANELS & CANS

STANDARD SIZES ON HAND
SPECIAL SIZES MADE TO ORDER

KORROL RADIO PRODUCTS CO.

232 Greenwich St. RW 238 New York City

TELEVISION

"TELEVISION WITH CATHODE RAYS," by Arthur H. Halloran, Farnsworth and Zworykin systems fully explained. The treatment is mathematical. It is a book for the well-grounded radio man who has vision, the man who wants to be among the first to cash in when the pictures go on the air commercially, but is not for novices. 100 pages or more of supplementary data. Price \$2.75 postpaid including Supplements).

RADIO WORLD

145 West 45th Street, New York City, N. Y.

When writing to Advertisers please mention that you saw the Advertisement in RADIO WORLD.

SPECIAL 2-FOR-1 OFFER RADIO WORLD

Radio World is \$2.50 a year (12 issues), 25c. per copy. Canada and foreign, \$3.00 yearly. Offers of Radio World and other worthwhile publications for one full year on each (NET):

- RADIO WORLD and SHORT-WAVE and TELEVISION, \$3.50.
- RADIO WORLD and POPULAR SCIENCE MONTHLY, \$3.50.
- RADIO WORLD and RADIO-CRAFT (12 issues), \$3.50.
- RADIO WORLD and RADIO INDEX (monthly, 10 issues), stations, programs, etc., \$3.50.
- RADIO WORLD and EVERYDAY SCIENCE AND MECHANICS (monthly), \$3.50.
- RADIO WORLD and BOYS' LIFE (monthly, 12 issues), \$3.50.
- RADIO WORLD and TRUE STORY (monthly), \$3.00.

Select any one of these magazines and get for an entire year by sending in a year's subscription for RADIO WORLD at the regular price, \$2.50, plus a small additional amount, per quotations above (Add \$1.50 for extra foreign or Canadian postage for both publications.)

Name

Address

City and State.....

- If renewing an existing or expiring subscription for RADIO WORLD, put cross in square.
- If renewing an existing or expiring subscription for other magazines, put cross in square.

Special Trial Offer for Radio World only: \$1.00 for 5 months. postpaid. Mail order with remittance to Radio World Office. NET.

RADIO WORLD, 145 W. 45th St., New York



IN TROUBLE SHOOTING! CLEWS
SPEED UP YOUR SERVICE WORK with these amazing new "TWIN" pocket-size radio TROUBLE-SHOOTER "GADGETS". Don't finker and puzzle over "SICK" radio receivers you must repair—get the habit of CHECKING FIRST with Ghirardi's Trouble-Shooters for they point the way directly to over **800 DIFFERENT RECEIVER TROUBLES**—and their REMEDIES. These "high-light" trouble finders are the cleverest, handiest servicing aids you've ever seen! **HOW THEY WORK:** Easy as pie to use—when you take up your Gadget, peek out the eyeletted card marked for the particular Trouble Symptom you find in the "sick" receiver. Flip the card around, and there you'll see all the possible Causes for the particular Trouble, the exact Tests to make, and the Remedies to apply. Work quick as a flash—almost like magic! Get you right to the trouble in a jiffy, without "fussing" around. One 8-card Gadget for HOME RADIOS—one with 12-cards for AUTO RADIOS. Only \$1 a pair, \$1.20 foreign.
MAIL \$1.00
 PIN A DOLLAR TO THIS AD, write your name and address in the margin, and mail. **NOW for both Gadgets.** Sent postpaid anywhere on 5-day trial!
RADIO & TECHNICAL PUBL. CO.
 Dept. RW-28
 45 Astor Pl., New York

CLASSIFIED ADVERTISEMENTS
 7 cents a word. \$1.00 minimum.

AMATEUR RADIO, Commercial Radiotelephone and Radiotelegraph licenses, complete training, Resident and correspondence courses. Every graduate a licensed operator. NEW YORK WIRELESS SCHOOL, 14 E. 44th St., New York, N.Y.

1000 BUSINESS CARDS (up to 6 lines) \$1.25. Ed. Keers 309 Scribner, Joliet, Illinois.

HAVE YOU BACK NUMBERS of Radio World, for May, August, 1935, or April, June, September, October, December, 1936, March, 1937? If so, please communicate with Radio World, 145 West 45th St., New York, N. Y.

RADIO EXPERIMENTERS AND SET BUILDERS: Darts and kits of parts for Improved Little Giant R235, six tube R233, Pre-amplifier R228, Portable battery R223, Little Giant R220 and 205 and 6 volt R238. Guaranteed specified parts. Lund Manufacturing Co., Dept. R.W., 43 East Ohio, Chicago.

MAKE YOUR OWN PRODUCTS. Employ agents yourself. Toilet articles, soap, extracts. We furnish everything. Valuable book free. National Scientific Laboratories, 1950 R.W. Broad, Richard, Va.

RADIO WORLD AND POPULAR MECHANICS MAGAZINE—Radio World is \$2.50 a year, and Popular Mechanics Magazine is \$2.50 a year. Popular Mechanics Magazine does not cut rates, but Radio World will send both publications to you for one year for \$3.75. **RADIO WORLD, 145 West 45th Street, New York City.**

A NEW YEAR'S GIFT FOR HIM

Is your husband, son or nephew interested in radio? Why not send him Radio World for the coming year?

We will send him, at your request, a post card notice telling him of your thoughtfulness in sending a gift that lasts all year!

For \$2.50 a year in the United States he will be reminded of your generosity every time the magazine arrives.

RADIO WORLD, 145 WEST 45th St., NEW YORK CITY

INDUCTANCE BOOK

Free! Every solenoid for every radio-frequency or intermediate frequency may be wound of standard wire on standard form diameters without any computations by using "The Inductance Authority," by Edward M. Shiepe. This \$2 book sent free, postpaid, with supplement, on receipt of \$5 for a 2-year subscription for RADIO WORLD.

RADIO WORLD, 145 W. 45th St., N. Y. C.



Text-Book for Home Study
 This complete, up-to-the-minute, practical book will teach you quickly how to service all types of refrigerators. Page after page of useful, easy to understand facts. Refrigeration is the big money field and you can get into it after studying this textbook. Size 8 1/2 x 11 in. Priced at only \$1.00, postpaid. Send for your copy now.

SUPREME PUBLICATIONS
 3729 WEST 18th STREET CHICAGO, ILL.



● Everything you need in radio. It's all in this new **RADOLEK RADIO PROFIT GUIDE**. Every repair part for every receiver. Newest radio receivers. New 1938 model public address amplifiers, outputs for 5 to 100 watts. New model public address speakers. Test instruments, Technical books. Special equipment. Leading standard brands. Every item guaranteed. It must be right or we make it right.

And everything under one roof. You get what you want promptly, and exactly what you want. Radolek's immense stock plus Radolek's efficient organization insures you fastest service. 25,000 service men depend on this service and benefit by Radolek's Radio Profit Guide. It will help you make more money.

---RADOLEK---

601 W. Randolph, Chicago, Dept. G-15

Send me the 1938 Radolek Radio Profit Guide FREE.

Name

Address

Service man? Dealer? Experimenter?

• • SENSATIONAL • • •

New! Improved All Purpose Tester

FEATURES . . .

- ★ D'Arsonval Meter, Guaranteed 2% Accuracy (1000 ohms per volt).
- ★ D.C. Voltage Readings 0-5-50-500-1000.
- ★ D.C. Milliampere Readings 0-1-10-100-500.
- ★ Resistance Readings 0-500-500,000 ohms.
- ★ Entirely self-contained—no extras to buy.

A sensationally low priced instrument that will prove itself to be the busiest meter around the shop. Its accuracy plus its compactness makes it indispensable to the servicemen for general test purposes.

YOUR NET PRICE
COMPLETE

\$5.75



NEW! IMPROVED TUBE TESTER and A.C. and D.C. VOLT OHM-MILLIAMMETER

Again Powertone leads the field by designing a combination improved tube tester and A.C. + D.C. Volt-Ohm-Mil (1,000 ohms per volt).

Model 700 is a complete test analyzer, completely portable with streamline design for diagnosing trouble in any radio receiver.

- ★ Jewelled I D'Arsonval Meter (1,000 ohms per volt). 3" square.
- ★ Condenser Short test.
- ★ Neon Short test.
- ★ Separate Section tests.
- ★ English Reading (Good-Bad) Scale, colored.
- ★ A.C. + D.C. Volt-Ohm-Mil (1,000 ohms per v.).

- ★ D.C. Volts—0-5-50-500-1000
- ★ A.C. Volts—0-5-50-500-1000
- ★ D.C. Mils—0-5-50-500
- ★ Output meter
- ★ Ohms—0-500-500,000
- ★ Beautiful metal etched panel

Your
Net Price

\$18.95

SERVICEMEN! No need to fret over Receiver.
Any Circuit Diagram from any
Riders 1-8 Manuals. Each - - - **25c**

CONSULT OUR ENGINEERING STAFF FOR
YOUR P.A. REQUIREMENTS. Our Engineers
will show you HOW TO SAVE MONEY.

Write in for Free Copy of New S.W.,P.A., Test Equip. Catalog

POWERTONE ELECTRIC CORP.
177 GREENWICH STREET **NEW YORK**



THE NEW "SUPER-PRO"

Console MODEL

HAMMARLUND now presents the internationally famous "Super-Pro" 16-tube professional receiver in a distinctively designed, high fidelity console. Thus, those in the luxury of their homes can now also enjoy the superior "Super-Pro" results that professionals the world over depend on for the success of their difficult listening-post schedules. The console has been designed around the bass reflex principle—a new advanced sound system. In addition, a new type 15" speaker is used to attain remarkable high fidelity reproduction. The receiver is identical to the table model "Super-Pro," featuring such advancements as: two-tuned R.F. stages on all bands; electrical band spread; fractional micro-volt sensitivity; self-contained tuning unit (shown at lower right); noiseless and trouble-free cam switch; calibrated controls; models for 7½ to 240, 15 to 560, and 15 to 2000 meters, etc. . . . You will be proud to own this new "Super-Pro" console model! Write Department RW-2 for further details!

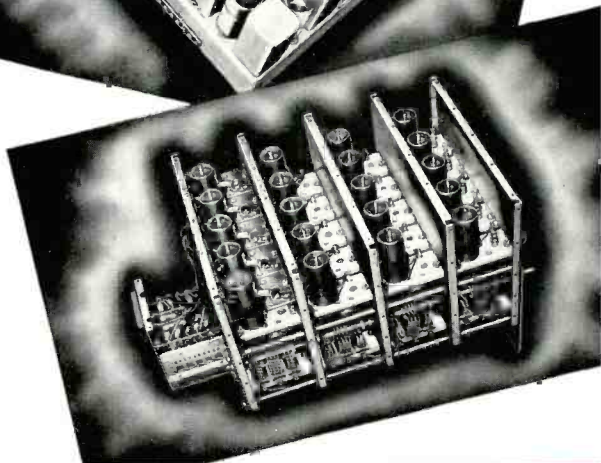
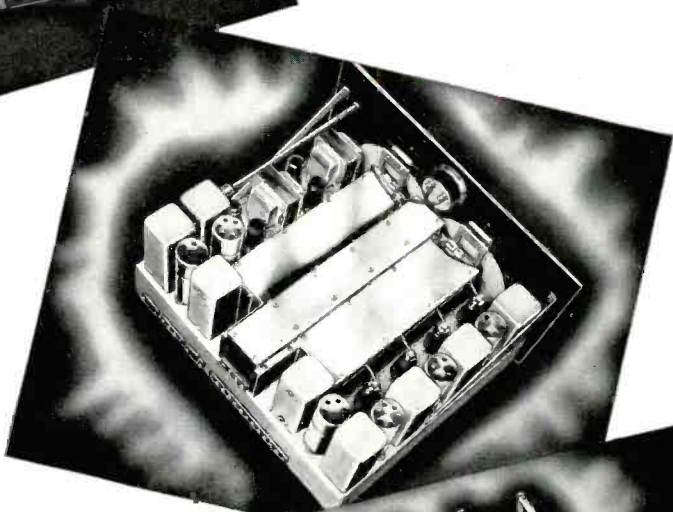

H A M M A R L U N D

HAMMARLUND MANUFACTURING CO., INC., 424-438 WEST 33RD ST., NEW YORK CITY

NEW SQUARE METERS RUGGEDLY CONSTRUCTED RELIABLE • LOW COST

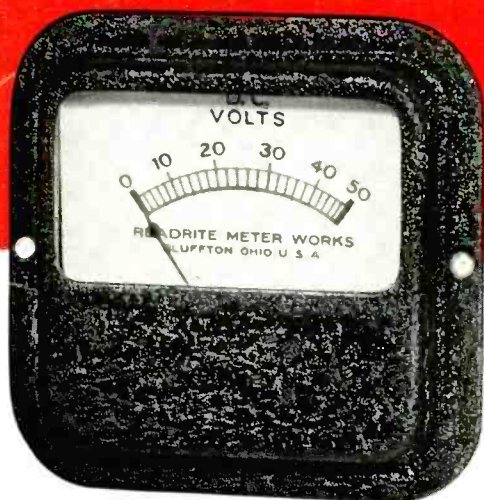

MODEL 95

This new line of meters has been developed by Readrite to fill the popular demand for square modernistic cases. Especial care has been taken to achieve the most suitable size and to give attractive proportions. Cases are finished in nickel, black wrinkle or black lacquer.

As in all Readrite meters this new line is ruggedly constructed and depend-

For amateurs, radio servicemen, sound men, engineers, manufacturers... wherever reliability is desired at low cost.

Case Size : $\left\{ \begin{array}{l} 2\frac{9}{16}'' \times 2\frac{5}{8}'' \\ \frac{3}{8}'' \text{ in front of Panel} \\ \frac{1}{8}'' \text{ in back of Flange} \end{array} \right.$

Voltmeters, ammeters, milliammeters in all popular ranges—A.C. and D.C.

ably accurate. D.C. are the polarized vane, solenoid type; A.C. are the double vane repulsion type. Easy to read... black figures on white scales.

READRITE is one of the oldest manufacturers of meters and has done a consistent business over a long period of years with some of the largest manufacturers in the country. Readrite quality is thoroughly reliable.

Ask Your Jobber — Write for Catalog

Readrite

TESTERS AND METERS

READRITE METER WORKS,
272 College Ave., Bluffton, Ohio.

Please send me more information on Readrite Square Meters.

I am also interested in.....

Name

Address

City..... State.....